

READ ALL INSTRUCTIONS COMPLETELY AND THOROUGHLY UNDERSTAND THEM BEFORE DOING ANYTHING.  
CALL CHASSISWORKS TECH SUPPORT (916) 388-0288 IF YOU NEED ASSISTANCE.

# INSTALLATION GUIDE

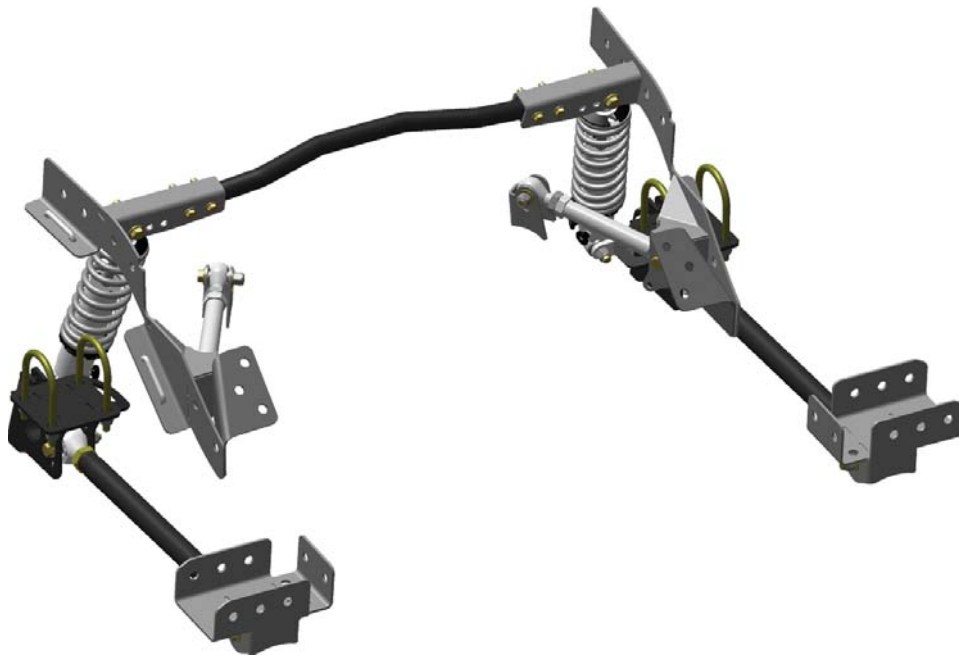

## 5804-X10 g-Link Canted 4-Bar Rear Coil-Over Suspension 1962-1967 Chevy II



**Description:** Canted 4-bar rear coil-over suspension for 1962-1967 Chevy II. Includes upper links, lower links, suspension cradle, axle brackets, and VariShock coil-overs.

**Note:** Installation requires welding

**IMPORTANT (Narrowed housings used with mini-tubs):** If your wheels do not clear the bolt-on lower axle brackets, weld-on brackets can be installed at a narrowed position. This requires g-Link or Billet g-Link pivot-ball arms. Test fit the wheels, brackets, and arms. Undamaged parts can be exchanged if needed.

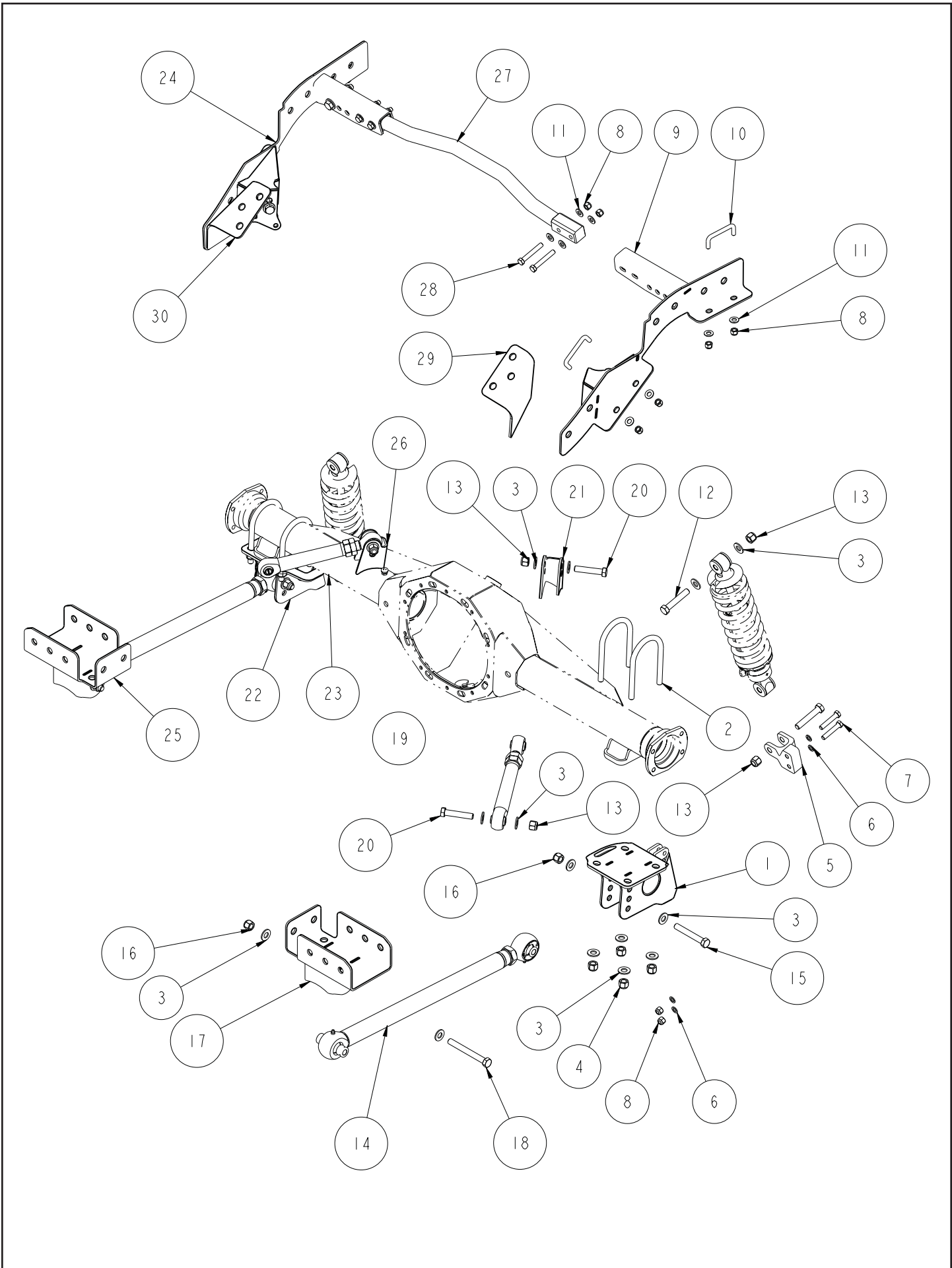

ITEM	QTY	PART NO.	DESCRIPTION
1	1	7959-0225	LOWER LINK MOUNT, DRV, G-BAR, REAR ARB, 62-67 CHEVY II / NOVA
2	4	3147-300.50-525	U-BOLT, AXLE TUBE, 1/2-20 x 3.00 x 5.25
3	28	3120-050S-Y	FLAT WASHER, 1/2 SAE, HARDENED, YELLOW ZINC
4	8	3131-050-20Y	LOCKNUT 1/2-20, GRADE 8, NYLON INSERT, YELLOW ZINC
5	1	1477-D	G-BAR STRAIGHT SHOCK MOUNT, DRIVER, ADJUSTABLE, OFFSET
6	8	3109-038-S-2-Y	AIRCRAFT WASHER 3/8 x .062 THICK
7	4	3100-038F2.00Y	HEX BOLT, 3/8-24 x 2, GRADE 8, YELLOW ZINC
8	16	3101-038-24C	LOCKNUT, 3/8-24, GRADE 5, NYLON INSERT, CLEAR ZINC
9	1	7959-0217	FRAME BRACKET WELDMENT, AXLE ARB, DRIVER, 62-67 CHEVY II / NOVA
10	4	3148-263.38-094	SQUARE BEND U-BOLT, 3/8-24 x 2.625 x .938
11	16	3120-038S-Y	FLAT WASHER, 3/8 SAE, HARDENED, YELLOW ZINC
12	4	3100-050F2.75Y	HEX BOLT, 1/2-20 x 2 3/4, GRADE 8, YELLOW ZINC
13	8	3101-050-20C	LOCKNUT, 1/2-20, GRADE 5, NYLON INSERT, CLEAR ZINC
14	2	3813-24.00-AD	LOWER LINK ASSEMBLY, G-LINK, 3.085 PIVOT BALL, 24 CENTER
15	2	3100-050C3.50Y	HEX BOLT, 1/2-13 x 3 1/2, GRADE 8, YELLOW ZINC
16	4	3101-050-13C	LOCKNUT 1/2-13, GRADE 5, NYLON INSERT, CLEAR ZINC
17	1	7959-0241	LCA BRACKET, CHASSIS, DRIVER, G-BAR, 62-67 CHEVY II / NOVA
18	2	3100-050C4.50Y	HEX BOLT, 1/2-13 x 4 1/2, GRADE 8, YELLOW ZINC
19	2	3814-09.50	G-LINK UPPER LINK ASSY, SA, BALL PIVOT, 9.50 CENTER LENGTH
20	4	3100-050F2.50Y	HEX BOLT, 1/2-20 x 2 1/2, GRADE 8, YELLOW ZINC
21	1	230230	UCA AXLE BRACKET, PSGR G-BAR, 64-70 MUSTANG
22	1	7959-0228	LOWER LINK MOUNT, PSGR, G-BAR, REAR ARB, 62-67 CHEVY II / NOVA
23	1	1477-P	G-BAR STRAIGHT SHOCK MOUNT, PSGR, ADJUSTABLE, OFFSET
24	1	7959-0221	FRAME BRACKET WELDMENT, AXLE ARB, PASSENGER, G-BAR, 62-67 CHEVY II / NOVA
25	1	7959-0244	LCA BRACKET, CHASSIS, PASSENGER, G-BAR, 62-67 CHEVY II / NOVA
26	1	230229	UCA AXLE BRACKET, DRIVER G-BAR, 64-70 MUSTANG
27	1	7959-0250	CROSS TUBE WELDMENT, SHOCK MOUNT, G-BAR, 62-67 CHEVY II / NOVA
28	4	3100-038F2.50Y	HEX BOLT, 3/8-24 x 2 1/2, GRADE 8, YELLOW ZINC
29	1	7959-0275	GUSSET, G-BAR UCA, DRV, 62-67 CHEVY II / NOVA
30	1	7959-0276	GUSSET, G-BAR UCA, PSGR, 62-67 CHEVY II / NOVA

DESCRIPTION		PART NO.	
<b>G-LINK, BALL PIVOT ARMS, 62-67 CHEVY II / NOVA, REAR SUSPENSION PACKAGE</b>		<b>5804-X10</b>	
<b>Chris Alston's CHASSISWORKS INC.</b> 8661 YOUNGER CREEK DRIVE SACRAMENTO, CA 95828 (916) 388-0288 FAX 388-0295		7/29/14	DWG: 915804-X10

# PARTS LIST

Prior to installation use the following parts lists to verify that you have received all components.

*NOTE: You will receive only one of the two Upper Suspension Link Sets listed below.*

## Upper Suspension Links - 300-0105 (pivot, single-adjustable)

2	3814-09.50	g-Link dual pivot-ball billet upper link assembly, 9-1/2" long
4	3100-050F2.75Y	Bolt, 1/2-20 x 2-3/4" hex head Grade 8
4	3101-050-20C	Locknut, 1/2-20 nylon insert
8	3120-050S-Y	Washer, 1/2" hardened flat SAE

## Upper Suspension Links - OPTION - 300-0145 (pivot, double-adjustable)

2	3818-09.00	g-Link dual pivot-ball, double-adjustable, billet upper link assembly, 9" long
4	3100-050F2.75Y	Bolt, 1/2-20 x 2-3/4" hex head Grade 8
4	3101-050-20C	Locknut, 1/2-20 nylon insert
8	3120-050S-Y	Washer, 1/2" hardened flat SAE

## Lower Suspension Links - 300-0118 (pivot)

2	3813-24.00-AD	g-Link dual pivot-ball tubular lower link assembly, 24" long
2	3100-050C3.50Y	Bolt, 1/2-13 x 3-1/2" hex head Grade 8
2	3100-050C4.75Y	Bolt, 1/2-13 x 4-3/4" hex head Grade 8
2	3100-050C6.50Y	Bolt, 1/2-13 x 6-1/2" hex head Grade 8
4	3101-050-13C	Locknut, 1/2-13 nylon insert
8	3120-050S-Y	Washer, 1/2" hardened flat SAE

## Lower Arm Chassis Brackets - 300-0178

1	7959-0241	Chassis bracket, driver side
1	7959-0244	Chassis bracket, passenger side

## Shock Absorber Components

*NOTE: You will receive only one of the three shock options listed below.*

1 (pair)	VAS 11111-515	Coil-over shocks, 5.15 travel, bearing eyes, single-adjustable
1 (pair)	VAS 11211-515	Coil-over shocks, 5.15 travel, bearing eyes, double-adjustable
1 (pair)	VAS 11411-50	Coil-over shocks, 5.15 travel, bearing eyes, 4-way remote reservoir
1	VAS 508-105	Spacer set for bearing mount shocks
1	VAS 517-RS-F	Single silo mount for shock reservoir (pair)

## Upper Shock Crossmember - 300-0180

1	7959-0250	Shock crossmember, X10
2	1533	Shock crossmember mounting block 1-5/16" wide

## Lower Shock Mounts - 300-0106

1	1477-D	Shock mount, billet aluminum, driver side
1	1477-P	Shock mount, billet aluminum, passenger side
4	3100-038F2.00Y	Bolt, 3/8-24 x 2" hex head Grade 8
2	3100-050F2.75Y	Bolt, 1/2-20 x 2-3/4" hex head Grade 8
4	3101-038-24C	Locknut, 3/8-24 nylon insert
2	3101-050-20C	Locknut, 1/2-20 nylon insert
8	3109-038-S-2-Y	Aircraft washer, 3/8" small OD

NOTE: You will receive only one of the four Axle Bracket Sets listed below.

## Axle Brackets (bolt-on lower) - 300-0167 - Omitted or Sliding-Link Anti-Roll Bar

1	230229	Upper axle bracket, driver side
1	230230	Upper axle bracket, passenger side
1	7959-0225	Lower axle bracket with anti-roll-bar tabs, driver side, bolt-on
1	7959-0228	Lower axle bracket with anti-roll-bar tabs, passenger side, bolt-on
8	3120-050S-Y	Washer, 1/2" hardened flat SAE
8	3131-050-20Y	Locknut, 1/2-20 nylon insert, Grade 8
4	3147-300.50-525	U-bolt, round 1/2-20 x 5-1/4" long x 3" ID

## Axle Brackets (bolt-on lower) - 300-0170 - Housing-Mount Anti-Roll Bar

1	230229	Upper axle bracket, driver side
1	230230	Upper axle bracket, passenger side
1	7959-0231	Lower axle bracket with anti-roll-bar bosses, driver side, bolt-on
1	7959-0232	Lower axle bracket with anti-roll-bar bosses, passenger side, bolt-on
8	3120-050S-Y	Washer, 1/2" hardened flat SAE
8	3131-050-20Y	Locknut, 1/2-20 nylon insert, Grade 8
4	3147-300.50-525	U-bolt, round 1/2-20 x 5-1/4" long x 3" ID

## Axle Brackets (weld-on lower) - 300-0176 - Omitted or Chassis-Mount Anti-Roll Bar

1	230229	Upper axle bracket, driver side
1	230230	Upper axle bracket, passenger side
1	7959-0233	Lower axle bracket with anti-roll-bar tabs, driver side, weld-on
1	7959-0236	Lower axle bracket with anti-roll-bar tabs, passenger side, weld-on

## Axle Brackets (weld-on lower) - 300-0177 - Housing-Mount Anti-Roll Bar

1	230229	Upper axle bracket, driver side
1	230230	Upper axle bracket, passenger side
1	7959-0239	Lower axle bracket with anti-roll-bar bosses, driver side, weld-on
1	7959-0240	Lower axle bracket with anti-roll-bar bosses, passenger side, weld-on

## Upper Axle Bracket Weld Fixtures - OPTIONAL

1	6727	Upper arm housing bracket fixture for GM 10-bolt
1	6728	Upper arm housing bracket fixture for GM 12-bolt
1	6729	Upper arm housing bracket fixture for Ford 9" or FAB9

NOTE: You will receive only one of the two Frame Bracket Sets listed below.

**Frame Bracket Set (no anti-roll-bar mounts) - 300-0168**

1	7959-0217	Frame bracket weldment, no anti-roll-bar mount, driver side
1	7959-0221	Frame bracket weldment, no anti-roll-bar mount, passenger side
1	7959-0275	Upper arm frame gusset, driver side
1	7959-0276	Upper arm frame gusset, passenger side
4	3100-038F2.50Y	Bolt, 3/8-24 x 2-1/2" hex head, Grade 8
2	3100-050F2.75Y	Bolt, 1/2-20 x 2-3/4" hex head, Grade 8
12	3101-038-24C	Locknut, 3/8-24 nylon insert, plated
2	3101-050-20C	Locknut, 1/2-20 nylon insert, plated
12	3120-038S-Y	Washer, 3/8" hardened flat SAE
4	3120-050S-Y	Washer, 1/2" hardened flat SAE
4	3148-263.38-094	Square U-bolt, 3/8-24 x 2-5/8" inside width x 15/16" long

**Frame Bracket Set (with anti-roll-bar mounts) - 300-0169**

1	7959-0200	Frame bracket weldment, with anti-roll-bar mount, driver side
1	7959-0209	Frame bracket weldment, with anti-roll-bar mount, passenger side
1	7959-0275	Upper arm frame gusset, driver side
1	7959-0276	Upper arm frame gusset, passenger side
4	3100-038F2.50Y	Bolt, 3/8-24 x 2-1/2" hex head, Grade 8
2	3100-050F2.75Y	Bolt, 1/2-20 x 2-3/4" hex head, Grade 8
12	3101-038-24C	Locknut, 3/8-24 nylon insert, plated
2	3101-050-20C	Locknut, 1/2-20 nylon insert, plated
12	3120-038S-Y	Washer, 3/8" hardened flat SAE
4	3120-050S-Y	Washer, 1/2" hardened flat SAE
4	3148-263.38-094	Square U-bolt, 3/8-24 x 2-5/8" inside width x 15/16" long

# INSTRUCTIONS

*NOTE: Photos were shot on a '67-69 Camaro. However, the installations are very similar. The steps described in this instruction guide apply to the Chevy II g-Bar/g-Link system.*

The g-Bar/g-Link canted 4-bar rear air suspension kit replaces the majority of components in your existing rear suspension. It is necessary to remove all of the existing components to prepare for installation.

1. Raise vehicle to a safe and comfortable working height. Use jack stands to support vehicle with suspension hanging freely. Make sure it is level front to rear and right to left.
2. Remove driveshaft, then all rear suspension components including the rubber snubbers mounted directly to the under-body and frame rails. Rubber snubbers must be replaced once welding and all clearance verification is complete. For additional clearance, the pinion snubber mount or additional brackets can be removed using a grinding disc.
3. Remove any portions of exhaust system that may interfere with installation. Mufflers in the stock location can remain in place. Unbolt or cut any exhaust tubing that is routed over the rear end housing.
4. Brake and fuel lines can remain on vehicle but will need to be secured along the body to prevent damage during installation.
5. The front leaf spring hangers will be removed using a cut-off wheel and upgraded to a stronger mounting bracket with standard Grade 8 hardware.
6. The replacement bracket fits over the frame rail and boxed understructure. Grind all weld areas and tack weld to hold securely.

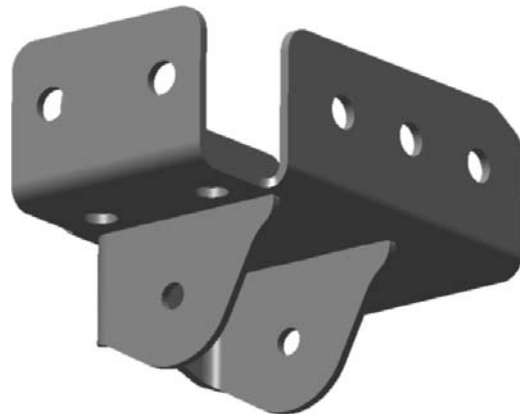
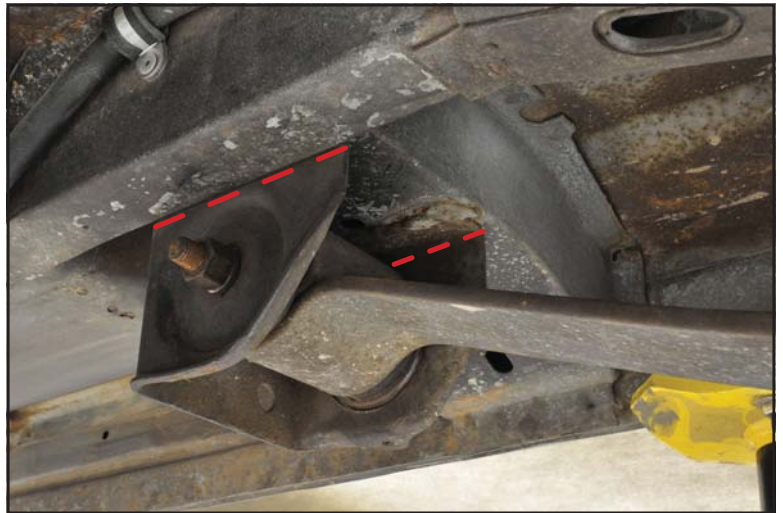

## Chassis Inspection

7. With the leaf springs out of the way, this is a good time to inspect the sheet metal for signs of fatigue. Clean the area to remove any grease or dirt so the metal and welds are clearly visible. Look for will have to be made before proceeding.



8. Bolt the driver and passenger frame brackets to the shock crossmember mounting blocks with the 3/8" bolts, flat washers and locknuts center in the slots.



9. Use C-clamps on the frame brackets to hold them firmly in place.

NOTE: It is most important that the brackets are completely seated against the frame rails. If the frame rails are in good condition, the brackets will rest flat along both contact surfaces.

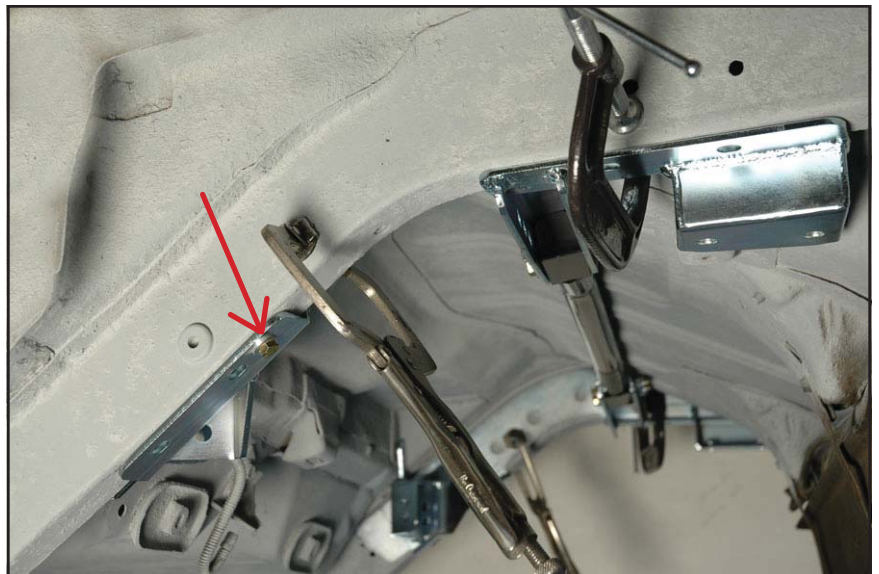



10. Ensure the cradle is positioned square to the chassis. On the driver side and passenger side, measure from a feature on each bracket to surfaces or points on the chassis that are known to be square. Measurements should be equal from one side of the vehicle to the other.



11. Verify the cradle frame brackets are clamped tightly against the inside and bottom surfaces of the frame rails.



12. Tighten the 3/8" upper crossmember mounting hardware to 35 lb-ft.



13. Clearly mark the weld-prep areas onto the undercarriage by scribing guidelines onto the surface of the frame rail. Scribe the overall outline of the bracket, the holes along the inside of the frame rail, and finally the eight oval holes along the bottom of the frame rail.



14. Use a 3/8"-diameter bit to drill a starting hole through the factory frame rail at each of the eight oval holes along the bottom of the frame rail ONLY. These holes will be opened up in a later step. The clamped cradle brackets will help to correctly guide the drill.



15. Unclamp the frame brackets but DO NOT loosen or remove the 3/8" upper-crossmember hardware at the frame brackets. Try not to bump the brackets from their correctly fit position. Lower the cradle assembly and set aside.



16. Use a die grinder, grinding-cone drill attachment, or file to enlarge the oval holes up to the scribe marks on the frame rails.



17. Use a scotch-brite disc pad or wire-brush drill attachment to expose bare metal along the weld areas marked on the frame rail earlier.



18. When all areas are sanded the frame should appear similar to the image to the right.



19. Install cradle into the car and align frame brackets with slotted holes in frame rail. Make sure it seats tightly against the frame rail.



20. Verify the cradle assembly is square within the chassis before clamping the cradle in place.



21. On one end of each square-corner u-bolt, install a 3/8" flat washer and locknut. DO NOT SKIP THIS STEP. It is possible to lose the u-bolt inside of the frame rail.



22. Slide the other end of the u-bolt into the hole in the frame brackets closest to the rear of the car, out through the second hole as shown, and secure with a flat washer and locknut.



23. Using the same procedure, install the U-bolt in the frame brackets closest to the front of car.



24. Once all the locknuts are in place, begin tightening each nut until it contacts the bracket. The u-bolt must “snugged-up” into a level, settled position before final tightening.

25. Torque each locknut to 35 lb-ft.

26. The installed cradle should appear similar to the image to the right.

27. Tack weld each bracket to the frame rail, and then stitch weld along the longer seam lengths. The seams at the forward end of the brackets should be completely welded with the bead extending 1” past the corner. Rosette weld around the holes on the inside of the frame rail, being careful not to burn through the frame rail. Use the photo below as a guide.

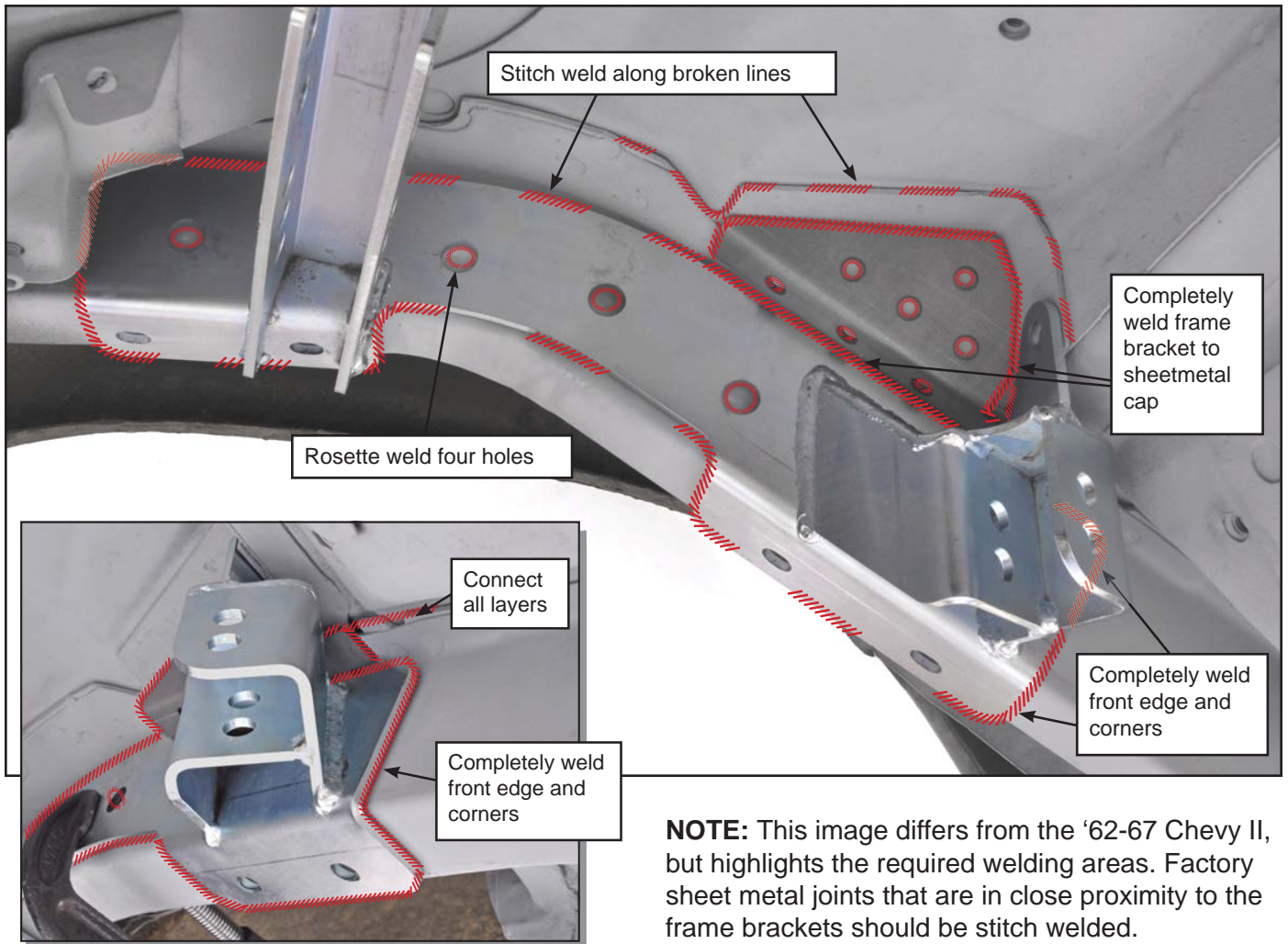

**NOTE:** This image differs from the '62-67 Chevy II, but highlights the required welding areas. Factory sheet metal joints that are in close proximity to the frame brackets should be stitch welded.

28. Once the main body of the frame bracket has been welded, the upper arm mount gusset must be positioned and welded.
29. Allow the welds to cool, then paint to protect the metal from rust.
30. Install the cover plates over the shock mounting holes using the factory bolts.
31. Apply a bead of body caulk or silicone to prevent water seepage.

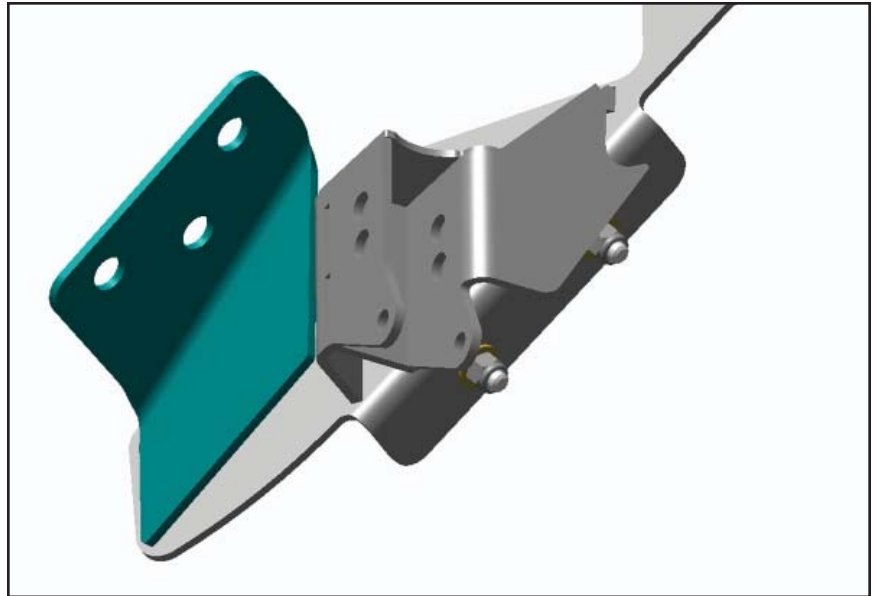

### Installation Using Factory Rear-end Housing

32. All fluid must be drained and residue removed from housing to reduce risk of fire during welding.
33. A weld fixture must be used to accurately position and weld the upper brackets to axle tube. The 10-bolt fixture is shown bolted to the rear of the housing.

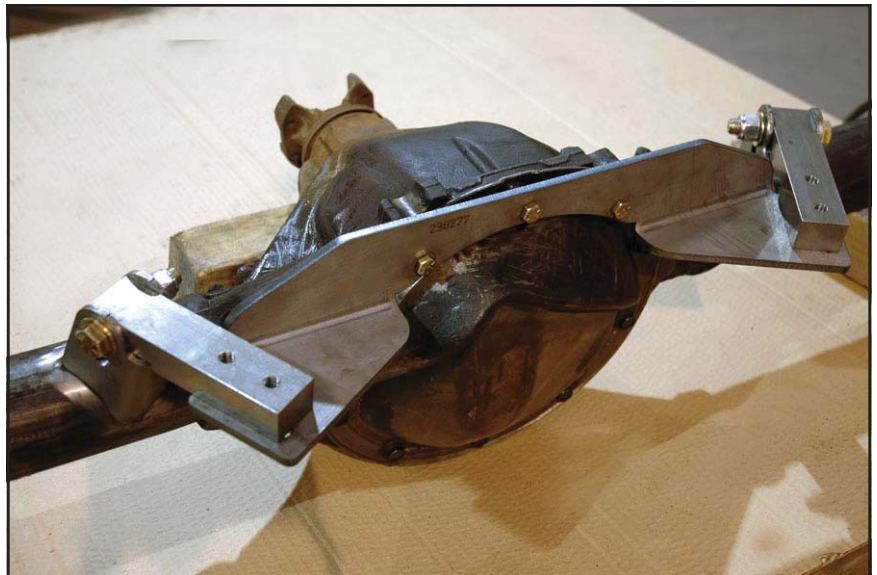

34. When leaving the rearend cover on the housings use the provided spacers. Also make sure the bracket bosses are at the forward holes. If welding with the cover removed the spacers are NOT used and the bracket bosses are mounted in the rear holes. Only tack weld the brackets at this time.

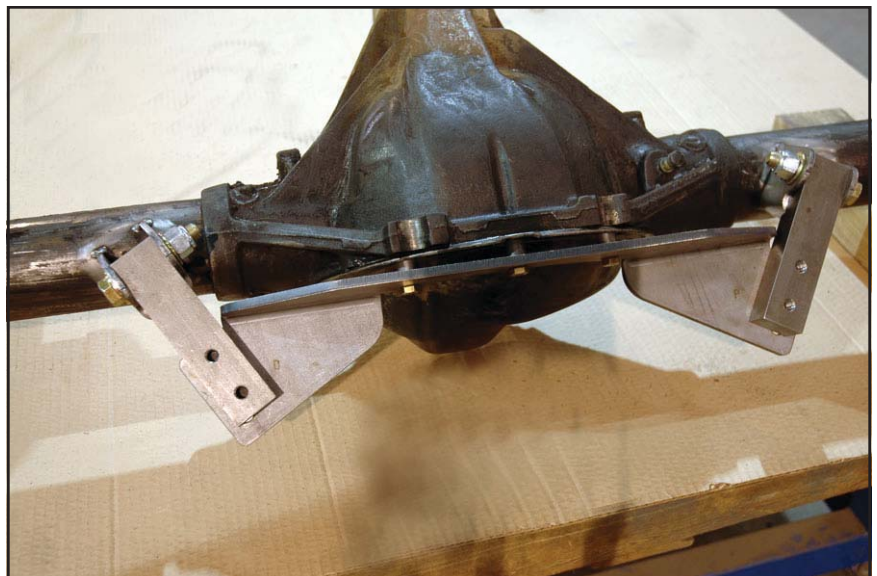

35. Use a 1/2" diameter drill bit to enlarge the holes in the factory spring plates for the u-bolts.

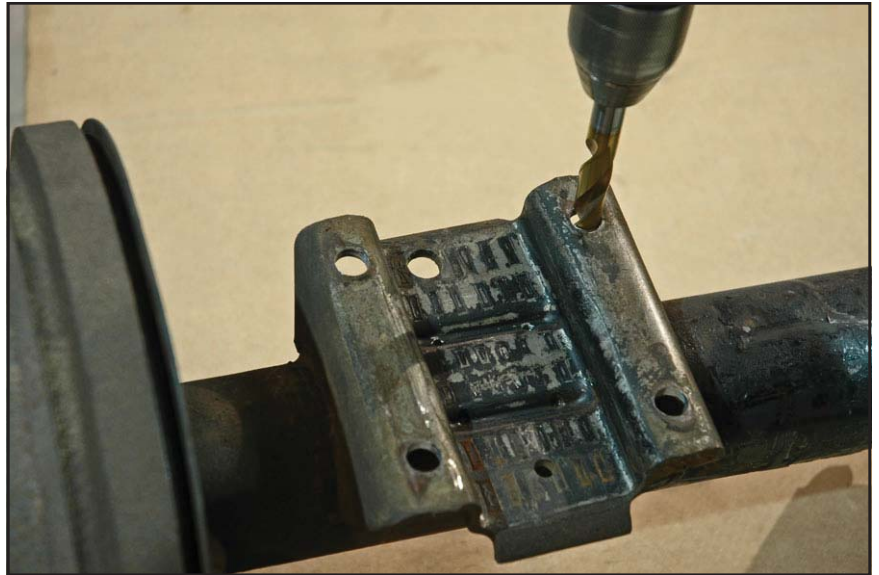

36. Position lower axle brackets onto rearend-housing spring plates. Place the 1/2" U-bolts over the axle tube and through the holes in the axle bracket. Secure with flat washers and locknuts. Tighten evenly to 60 lb-ft.

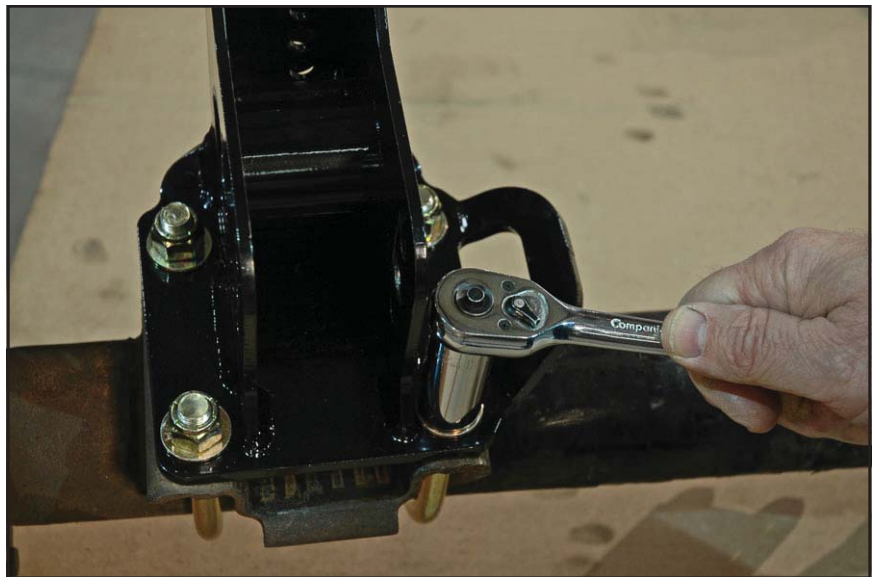

37. Adjust the lower link bars to 24" center to center of the mounting holes, if applicable.





38. Install the lower suspension links at the front chassis mount using 1/2" diameter bolts, flat washers, and locknuts. Grease zerks fittings must point downward. Torque to 65 lb-ft.

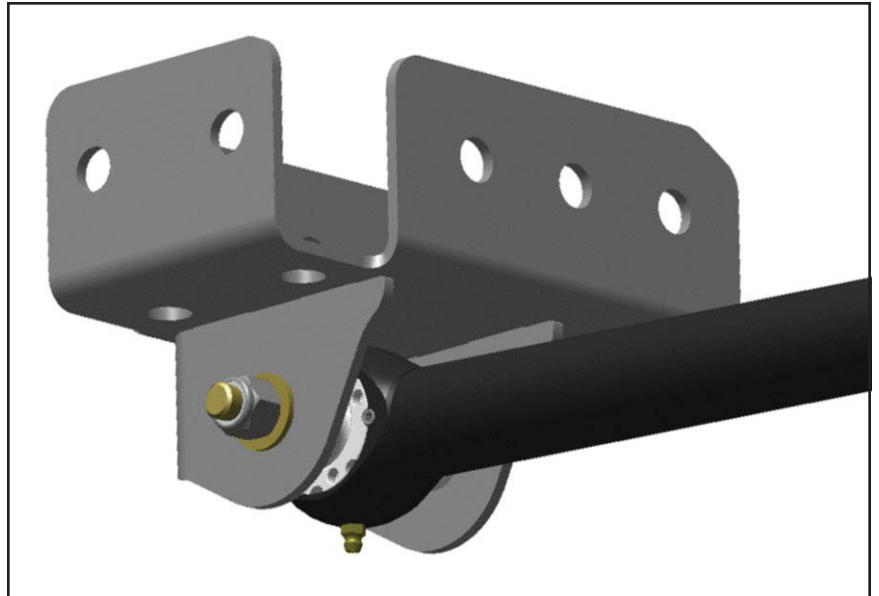

39. Position the rearend housing under the car on jack stands. Attach the lower suspension links to the axle brackets with 1/2" bolts, flat washers, and locknuts. Use the second hole from the bottom on the axle brackets for initial installation. Torque to 65 lb-ft.

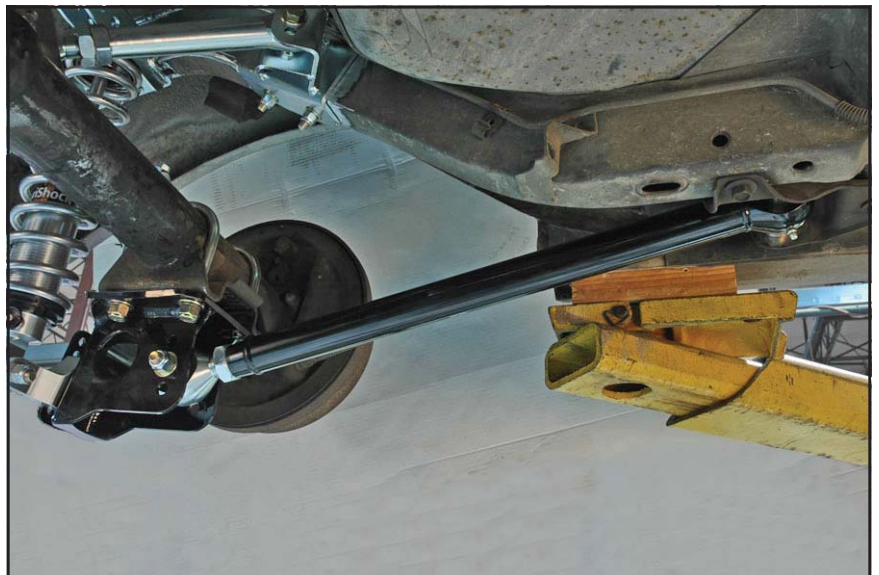

40. Adjust upper suspension links to 9-1/2" center to center of the mounting holes.



41. Attach the non-adjustable end of upper links to the upper holes of the cradle with 1/2" bolts, flat washers and locknuts. Grease zerk must point down.



42. Bolt opposite end of each upper link to the lower hole at the axle bracket. Grease zerk must point up.



43. Install the billet lower-shock mounts at the lower axle bracket using 3/8" hardware. Leave two blank holes below the mount for initial setup.

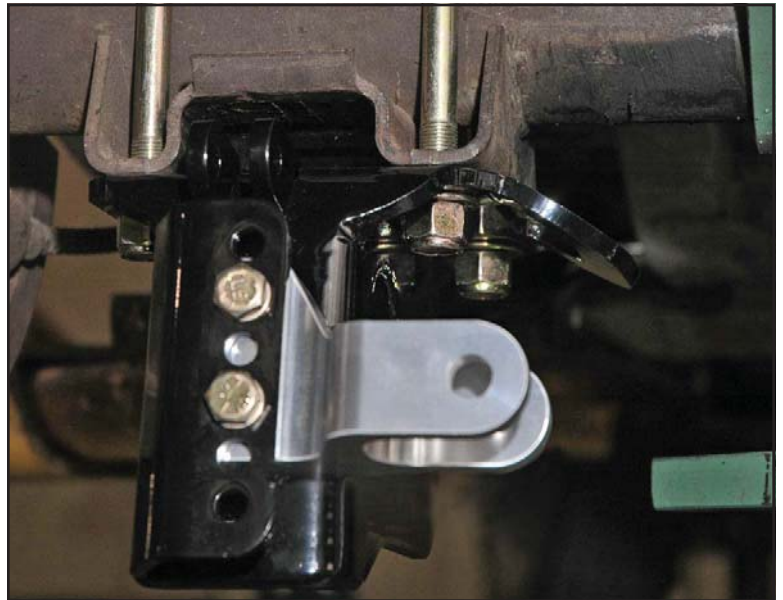

44. Raise rearend housing so that the distance from the billet-shock-mount hole to the center upper-shock-mount hole measures 11"; fully compressed.

45. Shock crossmember clearance must be verified at this time.

46. Once the clearance is verified, loosen the bolts and weld the block to the crossmember from the bottom as far around the tube as possible. Once the assembly is cool, remove the crossmember and final weld the top.

47. Grind the welds smooth so the crossmember fits the frame brackets properly.

48. Reinstall the shock crossmember and tighten the bolts.

49. Lower rearend housing so that the distance from the billet-shock-mount hole to the center upper-shock-mount hole measures 13-1/2". This is the baseline ride-height position.

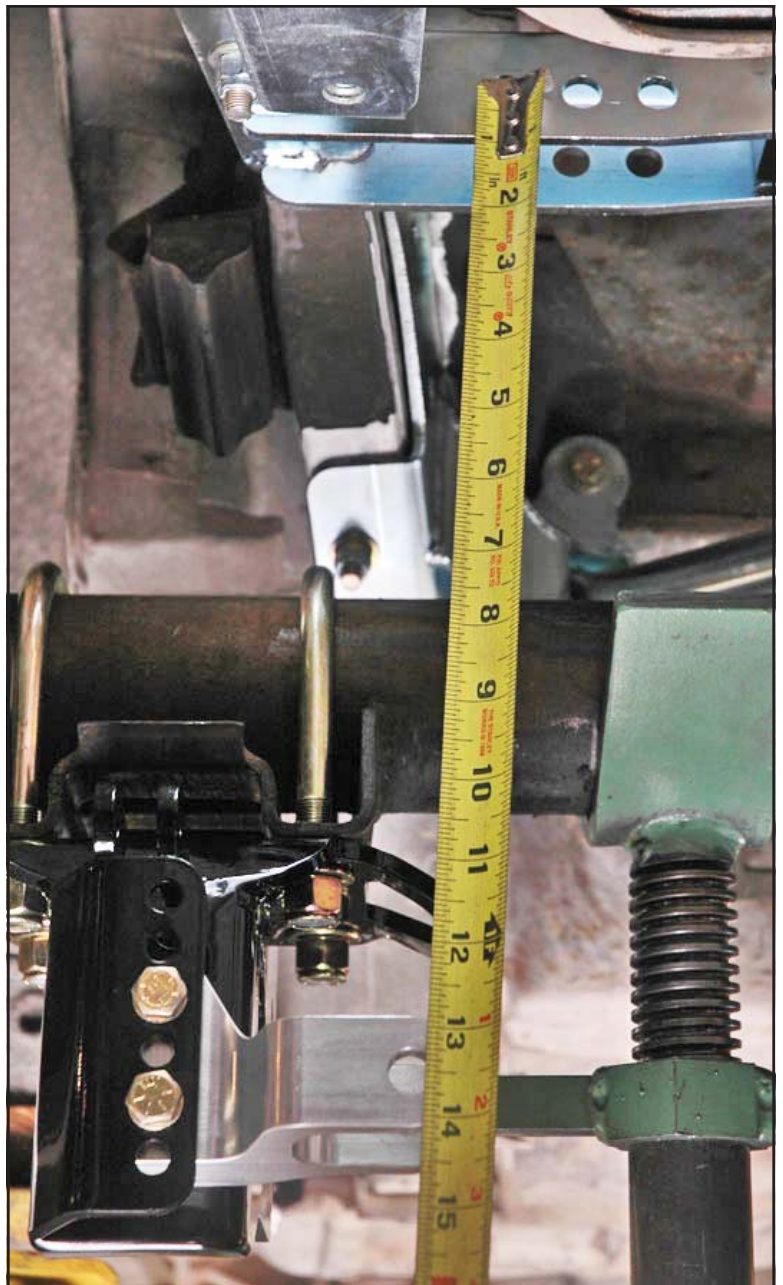

50. The upper suspension links can now be used to center the rearend in relation to the chassis, and then to adjust pinion angle. Link ends will need to be unbolted from axle brackets to adjust length. One full turn IN on one link and OUT on the other link will move the rearend housing approximately 3/16" toward the shortened side. Measuring from a point on the frame to the end of the axle on each side is the best way to center the housing in the car.



51. To adjust pinion angle turn both upper adjusters equal amounts IN or OUT.
52. Note: Carefully read the Pinion Angle section at the end of this installation guide before determining the correct pinion angle.



53. Install shocks with 1/2" bolts, flat washers and locknuts. Do not inflate springs at this time. The top shock eye should be mounted in the center hole. Adjustments can be made later to soften ride quality by moving to the inner hole, or stiffen ride quality by moving to the outer hole.
54. Adjust both shocks to their softest setting, then temporarily install into cradle using 1/2 x 2-3/4" bolts with locknuts.
55. Nuts can be threaded on by hand so that bolts do not slip out during next step. Shocks will be used to limit travel during next step.



56. Using a jack, cycle the rear suspension through its full range of vertical travel and body roll in both directions to check for binding and potential clearance issues at all suspension joints and along the lengths of any moving parts including the rearend housing. Remember the ShockWave® will be larger in diameter when inflated. Allow for an additional 1/2" to 3/4" of clearance around the air spring.





57. Once clearance has been verified, remove the housing and final weld the upper link brackets to the housing.

### Lowering Options

Customers wishing to lower their vehicle ride height beyond the factory clearance limitations have the option of purchasing add-on lowering kits. Installation of these kits requires removal of the pinion snubber mount and additional sheet metal modifications.

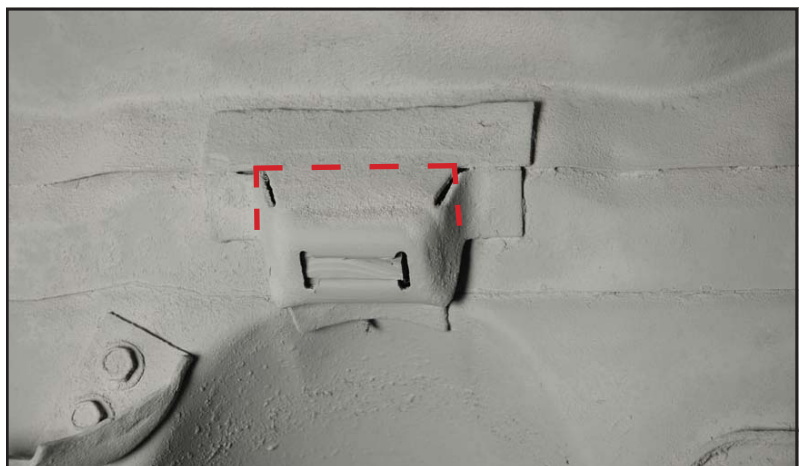

### Lowering Blocks

(P/N: 300-0162)

Use with bolt-on brackets.



### Shock Extenders

(P/N: 300-0163 or 300-0164)

Use with bolt-on or weld-on brackets



58. If possible, the exhaust system should be installed at this time while the rear end can be easily manipulated to check for proper clearance.
59. Coil springs can be installed, then shocks reinstalled onto cradle. Torque hardware to 50 lb-ft.
60. Refer to coil-over shock and VariSpring installation guides for specific instructions regarding adjusting spring preload and valve adjustment.
61. Note: When moving lower shock mounts or suspension link mounting locations the suspension must be checked for binding and adequate clearance throughout its full range of vertical travel and body roll.
62. Carefully read the shock angle section on page 31.
63. Refer to anti-roll-bar installation guide for specific instructions.
64. Reassemble the rear-end components and the installation is complete.



# Mounting Options and Final Adjustments

## Lower Suspension Link

**Mounting Position:** The lower link has three (factory housing) or four (FAB9™ housing) mounting positions at the axle bracket. Ideally, to minimize suspension steering effects (roll steer), the link should be set as close to horizontal as possible with the suspension at ride height. Lowering the rear position from horizontal will also increase available traction, but also increases roll oversteer.

**Length (pivot-ball link only):** Correct adjusted length is 24.00", measured at the center of the bolt holes. Due to chassis variances it may be necessary to adjust the lower suspension link lengths to position the rear end housing square to the chassis.

## Upper Suspension Link

**Mounting Position:** The upper link has two mounting positions at the cradle bracket and axle bracket. The starting installation position provides the largest anti-squat percentage and provides more immediate traction to the rear tires (less chassis movement). Lowering the front position and/or raising the rear position provides less anti-squat and a more gradual transfer of weight to the rear tires (more chassis movement).

**Length:** Correct adjusted length is 9.50", measured at the center of the bolt holes. Due to chassis variances it may be necessary to center the housing in relation to the chassis by adjusting the upper suspension link lengths.

## Shock Absorber

**Lower Mounting Position:** The lower shock mount can be moved to one of four positions to alter ride height in 5/8" increments.

**Upper Mounting Position:** The upper shock mount can be moved to one of three positions along the upper crossmember. Ride height is altered in 1/4" increments at each position with approximately a 5% change in shock/spring stiffness and ride quality. Outermost hole = highest/stiffest; Innermost hole = lowest/softest.

**Air Pressure:** Refer to ShockWave® installation guide (899-031-204 or 899-031-224) for detailed information regarding pressure settings and correct balance of travel at ride height.

*Under no circumstance should the shock length at ride height be less than 13-1/2" or more than 14-1/2" while driving the vehicle. Damage to the shock absorbers will occur, and you will be charged to repair them.*

## Maintenance

### Suspension Link Lubrication

Each suspension pivot assembly can be lubricated using a standard grease gun. Pivot-ball links without a grease zerk fitting can be lubricated by removing the locking set screw and temporarily installing a zerk fitting.

### Pivot-Ball Preload

The retaining ring can be tightened to remove any free-play that develops in the pivot-ball mechanism. Remove the locking set screw and turn the retaining ring clockwise, using a common spanner wrench, to the next set screw position.



# Pinion Angle

Our recommended pinion angle of one to two degrees down, as compared to the engine crankshaft angle, serves as a starting point for your particular application. Installed components, available traction, and specific application will have some affect on the correct settings for your vehicle.

Pinion angle is to be set at ride height by equally adjusting the upper control arm lengths. Upper arm must be unbolted from the axle tabs and jam nut loosened for adjustment. Be sure to tighten the jam nuts and mounting hardware to the torque value specified in this installation guide.

## Understanding Pinion Angle

The pinion angle is a very misunderstood measurement. The pinion angle is simply the difference in degrees of the engine crankshaft or drivetrain angle and the third member. The pinion angle is not a tuning aid. It is something that has to be set, but you do not adjust it for bite.

## Measuring the Drivetrain Angle

This can be taken from the vertical surface of the transmission tailshaft, the oil pan rail, or the front face of the harmonic balancer. Most production vehicle drivetrain angles will run slightly downhill towards the rear bumper. A typical measurement may be 2 degrees.

## Adjusting the Third Member Angle

The third member should be adjusted so that at ride height there is one to two degrees difference in the measured drivetrain angle and the third member angle. The pinion must point down 1 or 2 degrees from the engine or drivetrain angle. As an example, the two degrees downhill drivetrain angle previously established would require the third member to be set at zero degrees or parallel to the ground for a difference of two degrees. Lengthening the upper control arms to tilt the pinion upward to a measurement of one degree would give a difference of one degree when compared to the drivetrain angle.

Greater traction from wider or softer tire compounds combined with higher horsepower levels will require a greater pinion angle than low traction, low horsepower applications. The object is to get the two angles to be equal during acceleration. A poly-bushing link is more compliant and will flex more than the pivot-ball link, so poly links may require more initial pinion angle.

## Fastener Torque Specifications

Fastener Description	Location	Torque Value
5/16-24 x 1" Hex Head Cap Screw	Cradle to factory pinion bump stop mount	19 lb-ft
1/2-20 x 2-1/4 Hex Head Cap Screw, Grade 8	Shock mounts at cradle and lower shock mounts	50 lb-ft
7/16" U-bolts	Axle mount at leaf spring pad	50 lb-ft
5/8-18 x 2-3/4" Hex Head Cap Screw, Grade 8	Upper arm at cradle and welded axle tube mounts Lower arm at axle mount	75 lb-ft
5/8-18 x 1-1/2" Socket Head (Allen) Cap Screw	Lower shock mount to axle mount	75 lb-ft

## Shock Angle

The upper shock eye can be mounted in one of three positions to alter the effectiveness of the spring and shock against suspension movement. This adjustment can be used to soften or stiffen ride quality in roughly 5% increments. The center mount is the initial mounting position. Moving to the inner hole softens the suspension. Moving to the outer hole stiffens the suspension.

*If the shock angle is changed you must verify that the shock is still within the allowable ride height range of 13-1/2 to 14-1/2 inches, eye to eye.*

## Mount Position Effect on Ride

Inner	Center	Outer
-5%	Base	+5%

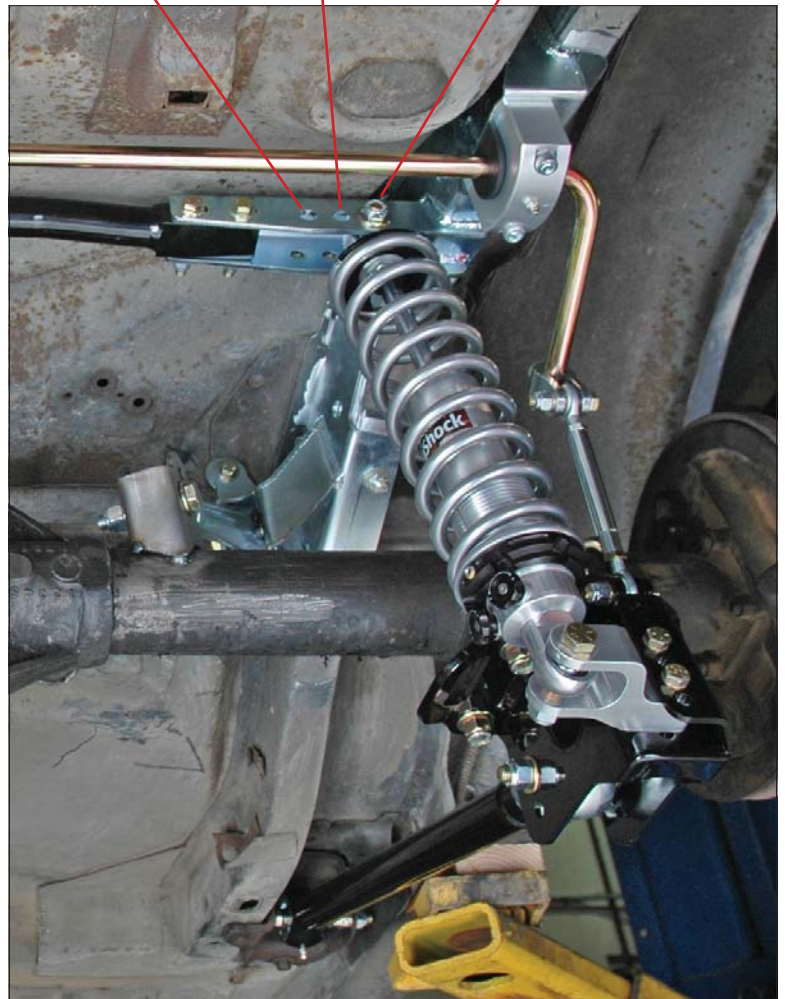

## NOTES:

**WARRANTY NOTICE:**

There are NO WARRANTIES, either expressed or implied. Neither the seller nor manufacturer will be liable for any loss, damage or injury, direct or indirect, arising from the use or inability to determine the appropriate use of any products. Before any attempt at installation, all drawings and/or instruction sheets should be completely reviewed to determine the suitability of the product for its intended use. In this connection, the user assumes all responsibility and risk. We reserve the right to change specification without notice. Further, Chris Alston's Chassisworks, Inc., makes **NO GUARANTEE** in reference to any specific class legality of any component. **ALL PRODUCTS ARE INTENDED FOR RACING AND OFF-ROAD USE AND MAY NOT BE LEGALLY USED ON THE HIGHWAY.** The products offered for sale are true race-car components and, in all cases, require some fabrication skill. **NO PRODUCT OR SERVICE IS DESIGNED OR INTENDED TO PREVENT INJURY OR DEATH.**

Chris Alston's Chassisworks  
8661 Younger Creek Drive  
Sacramento, CA 95828  
Phone: 916-388-0288  
Technical Support: [sales@cachassisworks.com](mailto:sales@cachassisworks.com)

