

READ ALL INSTRUCTIONS COMPLETELY AND THOROUGHLY UNDERSTAND THEM BEFORE DOING ANYTHING.
CALL CHASSISWORKS TECH SUPPORT (916) 388-0288 IF YOU NEED ASSISTANCE.

INSTALLATION GUIDE

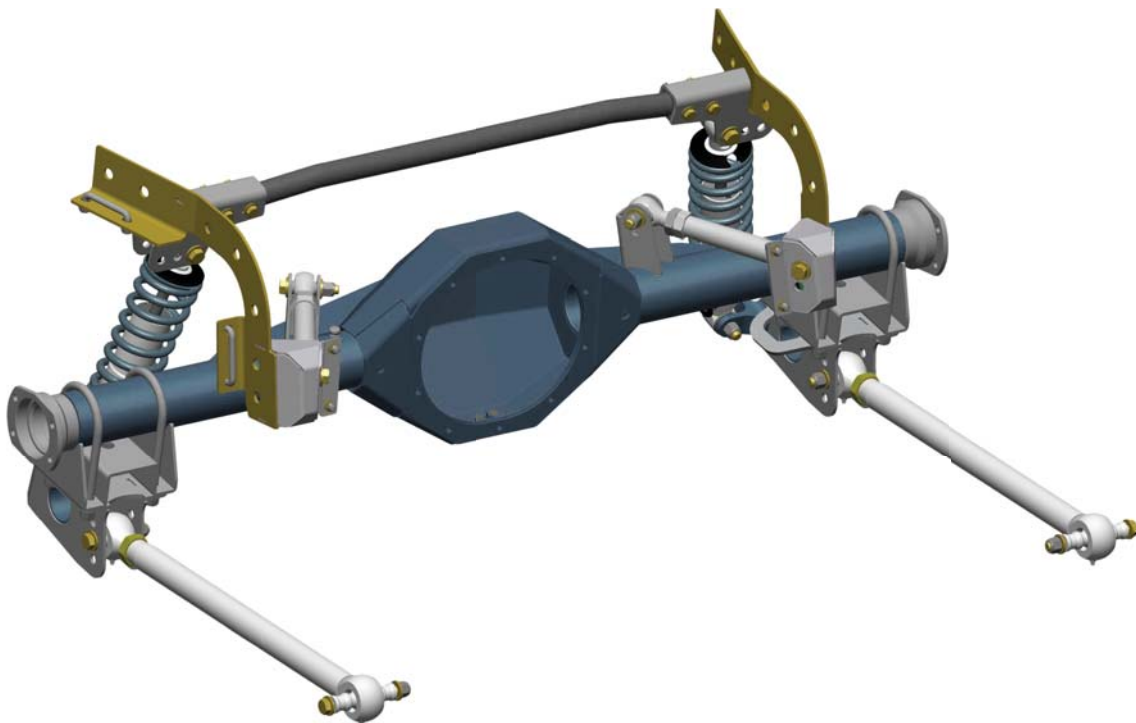

5804-F22 g-Link Canted 4-Bar Coil-Over Rear Suspension 1978-1981 Camaro & Firebird



Description: Canted 4-bar coil-over rear suspension for 1978-1981 Camaro and Firebird. Includes upper links, lower links, suspension cradle, axle brackets, shocks and springs

Note: Installation requires floor clearancing and welding.

IMPORTANT (Narrowed housings used with mini-tubs): If your wheels do not clear the bolt-on lower axle brackets, weld-on brackets can be installed at a narrowed position. This requires g-Link or Billet g-Link pivot-ball arms. Test fit the wheels, brackets, and arms. Undamaged parts can be exchanged if needed.

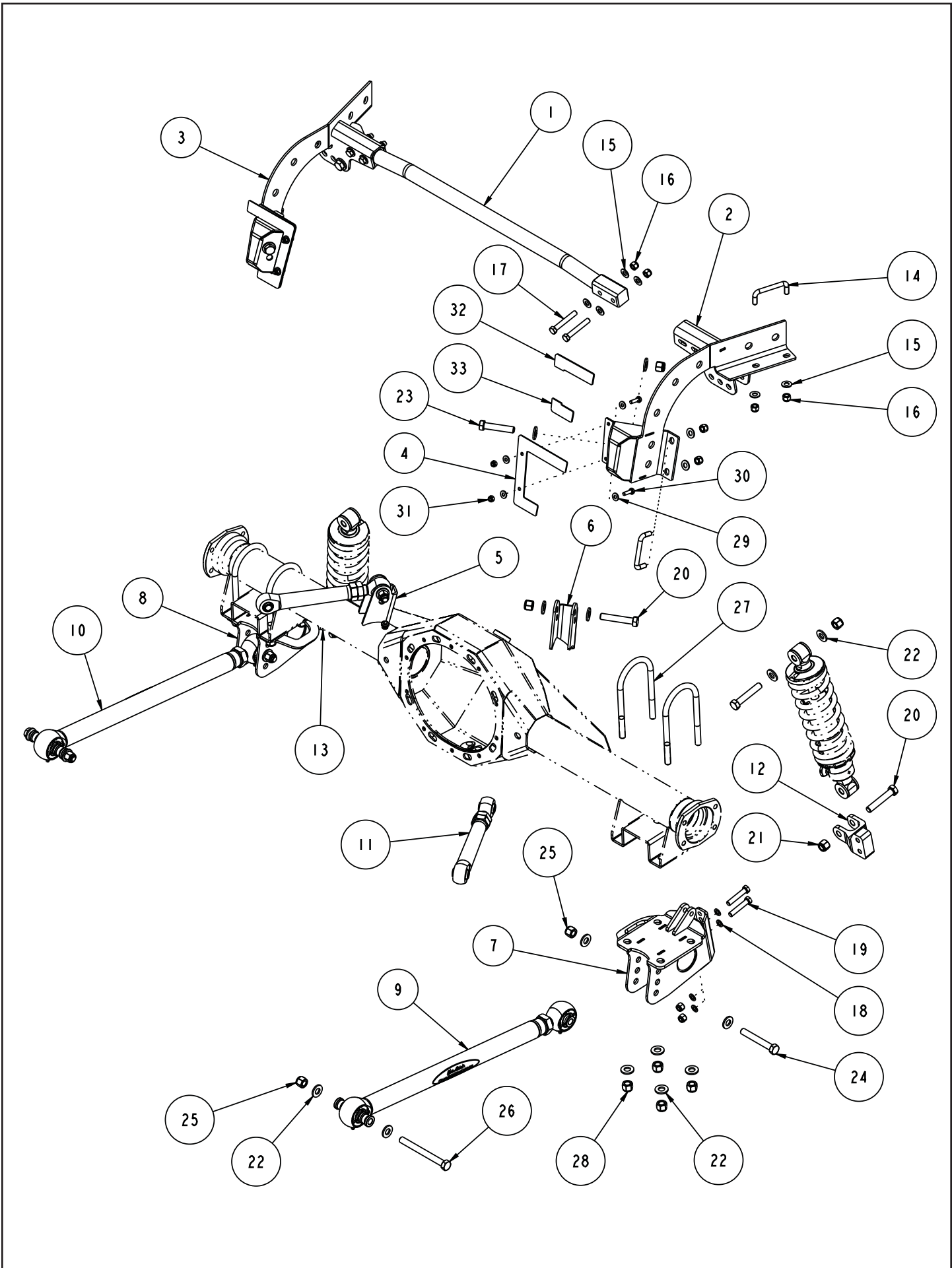

ITEM	QTY	PART NO.	DESCRIPTION
1	1	7959-0046	CROSS TUBE WELDMENT, SHOCK MOUNT, G-BAR, 70-81 CAMARO
2	1	7959-0087	FRAME BRACKET WELDMENT, DRIVER, NO ARB, G-BAR, 78-81 CAMARO
3	1	7959-0088	FRAME BRACKET WELDMENT, PASSENGER, NO ARB, G-BAR, 78-81 CAMARO
4	2	7959-0028	BACKING PLATE, FLOOR, UCA BRACKET, G-BAR, 70-81 CAMARO
5	1	7959-0048	UCA AXLE BRACKET, PASSENGER, G-BAR, 72 CAMARO
6	1	7959-0047	UCA AXLE BRACKET, DRIVER G-BAR, 70-81 CAMARO
7	1	7959-0038	LCA BRACKET WELDMENT, BOLT-ON, DRIVER, REAR ARB, G-BAR, 70-81 CAMARO
8	1	7959-0039	LCA BRACKET WELDMENT, BOLT-ON, PSGR, REAR ARB, G-BAR, 70-81 CAMARO
9	1	3813-24.00-AE	LOWER LINK ASSEMBLY, G-LINK, 3.710 PIVOT BALL, 24 CENTER
10	1	3813-24.00-AE	LOWER LINK ASSEMBLY, G-LINK, 3.710 PIVOT BALL, 24 CENTER
11	2	3814-09.50	G-LINK UPPER LINK ASSY, BALL PIVOT, 9.50 CENTER LENGTH
12	1	1477-D	G-BAR STRAIGHT SHOCK MOUNT, DRIVER, ADJUSTABLE, OFFSET
13	1	1477-P	G-BAR STRAIGHT SHOCK MOUNT, PSGR, ADJUSTABLE, OFFSET
14	4	3148-263.38-094	SQUARE BEND U-BOLT, 3/8-24 x 2.625 x .938
15	16	3120-038S-Y	FLAT WASHER, 3/8 SAE, HARDENED
16	16	3101-038-24C	LOCKNUT, 3/8-24, GRADE 5, NYLON INSERT, CLEAR ZINC
17	4	3100-038F2.50Y	HEX BOLT, 3/8-24 x 2 1/2, GRADE 8, YELLOW ZINC
18	8	3109-038-S-2-Y	AIRCRAFT WASHER 3/8 x .062 THICK
19	4	3100-038F2.00Y	HEX BOLT, 3/8-24 x 2, GRADE 8, YELLOW ZINC
20	6	3100-050F2.75Y	HEX BOLT, 1/2-20 x 2 3/4, GRADE 8, YELLOW ZINC
21	8	3101-050-20C	LOCKNUT, 1/2-20, GRADE 5, NYLON INSERT, CLEAR ZINC
22	28	3120-050S-Y	FLAT WASHER, 1/2 SAE, HARDENED
23	2	3100-050F2.50Y	HEX BOLT, 1/2-20 x 2 1/2, GRADE 8, YELLOW ZINC
24	2	3100-050C3.50Y	HEX BOLT, 1/2-13 x 3 1/2, GRADE 8, YELLOW ZINC
25	4	3101-050-13C	LOCKNUT 1/2-13, GRADE 5, NYLON INSERT, CLEAR ZINC
26	2	3100-050C5.00Y	HEX BOLT, 1/2-13 x 5, GRADE 8, YELLOW ZINC
27	4	3147-300.50-650	U-BOLT, AXLE TUBE, 1/2-20 x 3.00 x 6.50
28	8	3131-050-20Y	LOCKNUT 1/2-20, GRADE 8, NYLON INSERT, YELLOW ZINC
29	8	3120-025S-Y	FLAT WASHER, 1/4 SAE, HARDENED
30	4	3100-025F0.88Y	HEX BOLT, 1/4-28 x 7/8, GRADE 8, YELLOW ZINC
31	4	3101-025-28C	LOCKNUT 1/4-28, GRADE 5, NYLON INSERT, CLEAR ZINC
32	2	7959-0029	FLOOR STRIP, UCA BRACKET, UPPER, G-BAR, 70-81 CAMARO
33	2	7959-0097	FLOOR STRIP, UCA BRACKET, LOWER, G-BAR, 70-81 CAMARO
34	1	7959-0053	TEMPLATE, FLOOR CUT-OUT, G-BAR, 70-81 CAMARO/FIREBIRD

DESCRIPTION	
G-BAR, 78-81 CAMARO/FIREBIRD, BALL PIVOT, REAR SUSPENSION PACKAGE	
<i>Chris Alston's</i> CHASSISWORKS INC. 8661 YOUNGER CREEK DRIVE SACRAMENTO, CA 95828 (916) 388-0288 FAX 388-0295	PART NO.
	5804-F22
4/19/11	DWG: 915804-F22

PARTS LIST

Prior to installation use the following parts lists to verify that you have received all components.

Lower Suspension Links - 300-0122 (pivot)

Qty	Part Number	Description
2	3813-24.00-AE	g-Link dual pivot-ball tubular lower link assembly, 24" long
2	3100-050C3.50Y	Bolt, 1/2-13 x 3-1/2" hex head Grade 8
2	3100-050C5.00Y	Bolt, 1/2-13 x 5" hex head Grade 8
4	3101-050-13C	Locknut, 1/2-13 nylon insert
8	3120-050S-Y	Washer, 1/2" hardened flat SAE
NOTE	Offset-arm option receives 300-0140 with 3816-24.00-AED and 3816-24.00-AEP arm assemblies.	

Upper Suspension Links - 300-0105 (pivot)

Qty	Part Number	Description
2	3814-09.50	g-Link dual pivot-ball billet upper link assembly, 9-1/2" long
4	3100-050F2.75Y	Bolt, 1/2-20 x 2-3/4" hex head Grade 8
4	3101-050-20C	Locknut, 1/2-20 nylon insert
8	3120-050S-Y	Washer, 1/2" hardened flat SAE

Lower Shock Mounts - 300-0106

Qty	Part Number	Description
1	1477-D	Shock mount, billet aluminum, driver side
1	1477-P	Shock mount, billet aluminum, passenger side
4	3100-038F2.00Y	Bolt, 3/8-24 x 2" hex head Grade 8
2	3100-050F2.75Y	Bolt, 1/2-20 x 2-3/4" hex head Grade 8
4	3101-038-24C	Locknut, 3/8-24 nylon insert
2	3101-050-20C	Locknut, 1/2-20 nylon insert
8	3109-038-S-2-Y	Aircraft washer, 3/8" small OD

Shock Absorber Components

Qty	Part Number	Description
1 (pair)	VAS 11X22-515	VariShock coil-over QuickSet 1, 5.15 travel, 16.10 extended, poly bushed ends (QuickSet 2 optional)
1 (pair)	VAS 21-12XXX	VariSprings 12" long (spring rate optional)

NOTE: You will receive only one of the four axle-mount sets listed.

Axle Mounts - 300-0151 (for multi-leaf spring pads and sliding-link anti-roll bar)

Qty	Part Number	Description
8	3120-050S-Y	Washer, 1/2" hardened flat SAE
8	3131-050-20Y	Locknut, 1/2-20 nylon insert, Grade 8
4	3147-300.50-650	U-bolt, round 1/2-20 x 6-1/2" long x 3" ID
1	7959-0038	Lower axle bracket with endlink mount for multi-leaf spring pad, driver side
1	7959-0039	Lower axle bracket with endlink mount for multi-leaf spring pad, passenger side
1	7959-0047	Upper axle bracket, driver side
1	7959-0048	Upper axle bracket, passenger side

Axle Mounts - 300-0152 (for multi-leaf spring pads and splined-end anti-roll bar)

Qty	Part Number	Description
8	3120-050S-Y	Washer, 1/2" hardened flat SAE
8	3131-050-20Y	Locknut, 1/2-20 nylon insert, Grade 8
4	3147-300.50-650	U-bolt, round 1/2-20 x 6-1/2" long x 3" ID
1	7959-0040	Lower axle bracket with anti-roll-bar boss for multi-leaf spring pad, driver side
1	7959-0041	Lower axle bracket with anti-roll-bar boss for multi-leaf spring pad, passenger side
1	7959-0047	Upper axle bracket, driver side
1	7959-0048	Upper axle bracket, passenger side

Axle Mounts - 300-0153 (weld-on brackets and sliding-link anti-roll bar)

Qty	Part Number	Description
1	7959-0042	Lower axle bracket with endlink mount for weld-on installation, driver side
1	7959-0043	Lower axle bracket with endlink mount for weld-on installation, passenger side
1	7959-0047	Upper axle bracket, driver side
1	7959-0048	Upper axle bracket, passenger side

Axle Mounts - 300-0154 (weld-on brackets and splined-end anti-roll bar)

Qty	Part Number	Description
1	7959-0044	Upper axle bracket, driver side
1	7959-0045	Upper axle bracket, passenger side
1	7959-0047	Lower axle bracket with anti-roll-bar boss for weld-on installation, driver side
1	7959-0048	Lower axle bracket with anti-roll-bar boss for weld-on installation, passenger side

NOTE: You will receive only one of the two frame-bracket sets listed below.

Frame Bracket Set '78-81 Camaro - 300-0160 (no anti-roll-bar mounts)

Qty	Part Number	Description
4	3100-025F0.88Y	Bolt, 1/4-28 x 7/8" hex head, Grade 8
4	3100-038F2.50Y	Bolt, 3/8-24 x 2-1/2" hex head, Grade 8
2	3100-050F2.75Y	Bolt, 1/2-20 x 2-3/4" hex head, Grade 8
4	3101-025-28C	Locknut, 1/4-28 nylon insert, plated
12	3101-038-24C	Locknut, 3/8-24 nylon insert, plated
2	3101-050-20C	Locknut, 1/2-20 nylon insert, plated
8	3120-025S-Y	Washer, 1/4" hardened flat SAE
16	3120-038S-Y	Washer, 3/8" hardened flat SAE
4	3120-050S-Y	Washer, 1/2" hardened flat SAE
4	3148-263.38-094	Square U-bolt, 3/8-24 x 2-5/8" inside width x 15/16" long
2	7959-0028	Floor UCA backing plate F20
2	7959-0029	Floor weld plate UCA bracket F20
1	7959-0085	Frame bracket weldment with no anti-roll-bar mount, driver side
1	7959-0086	Frame bracket weldment with no anti-roll-bar mount, passenger side
1	7959-0046	Upper shock crossmember (packaged in 300-0147)
1	7959-0053	Template F20 g-Bar UCA floor cutout
2	7959-0097	Floor strip below UCA bracket F20
2	7959-0099	UCA backing plate

Frame Bracket Set '78-81 Camaro - 300-0159 (anti-roll-bar mounts)

Qty	Part Number	Description
4	3100-025F0.88Y	Bolt, 1/4-28 x 7/8" hex head, Grade 8
4	3100-038F2.50Y	Bolt, 3/8-24 x 2-1/2" hex head, Grade 8
2	3100-050F2.75Y	Bolt, 1/2-20 x 2-3/4" hex head, Grade 8
4	3101-025-28C	Locknut, 1/4-28 nylon insert, plated
12	3101-038-24C	Locknut, 3/8-24 nylon insert, plated
2	3101-050-20C	Locknut, 1/2-20 nylon insert, plated
8	3120-025S-Y	Washer, 1/4" hardened flat SAE
16	3120-038S-Y	Washer, 3/8" hardened flat SAE
4	3120-050S-Y	Washer, 1/2" hardened flat SAE
4	3148-263.38-094	Square U-bolt, 3/8-24 x 2-5/8" inside width x 15/16" long
2	7959-0028	Floor UCA backing plate F20
2	7959-0029	Floor weld plate UCA bracket F20
1	7959-0087	Frame bracket weldment with anti-roll-bar mount, driver side
1	7959-0088	Frame bracket weldment with anti-roll-bar mount, passenger side
1	7959-0046	Upper shock crossmember (packaged in 300-0147)
1	7959-0053	Template F20 g-Bar UCA floor cutout
2	7959-0097	Floor strip below UCA bracket F20
2	7959-0099	UCA backing plate

INSTRUCTIONS

The images in this installation guide were shot using a first-generation Camaro and will differ slightly from the second-generation F-body platform. The installation procedures are the same.

The g-Link Canted 4-Bar Rear Coil-Over Suspension Kit replaces the majority of components in your existing rear suspension. It is necessary to remove all of the existing components to prepare for installation.

1. Raise vehicle to a safe and comfortable working height. Use jack stands to support vehicle with suspension hanging freely. Make sure it is level front to rear and right to left.
2. Remove driveshaft, then all rear suspension components including the pinion snubber mounted directly to the under-body. The front leaf spring hangers will be reused. It is a good idea to use penetrating oil on the leaf-spring hanger bolts before trying to remove them, the clip nuts can be damaged if care is not take when removing the spring hangers.
3. Remove any portions of exhaust system that may interfere with installation. Mufflers in the stock location can remain in place. Unbolt or cut any exhaust tubing that is routed over the rear end housing.
4. Brake and fuel lines can remain on vehicle but will need to be secured along the body to prevent damage during installation.
5. Do not install springs onto coil-over shocks until after rear suspension has been checked for adequate travel clearance.

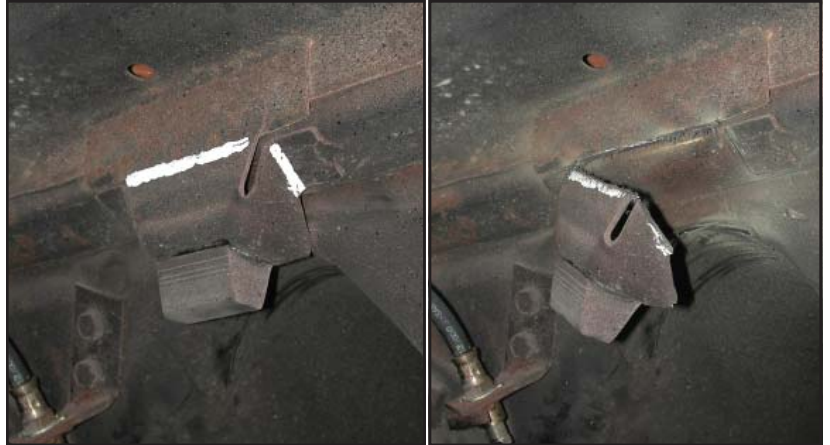

Chassis Inspection

6. With the leaf springs out of the way, this is a good time to inspect the sheet metal for signs of fatigue. Clean the area to remove any grease or dirt so the metal and welds are clearly visible. Look for will have to be made before proceeding.

7. The two frame brackets, upper shock crossmember, and hardware make up the cradle assembly.



8. Prepare frame rail brackets for welding to chassis (performed in a later step). Use disc sander with a fine grit pad to remove zinc coating along outside edges where the welds will be made. The zinc inside the larger holes can be removed with die grinder.

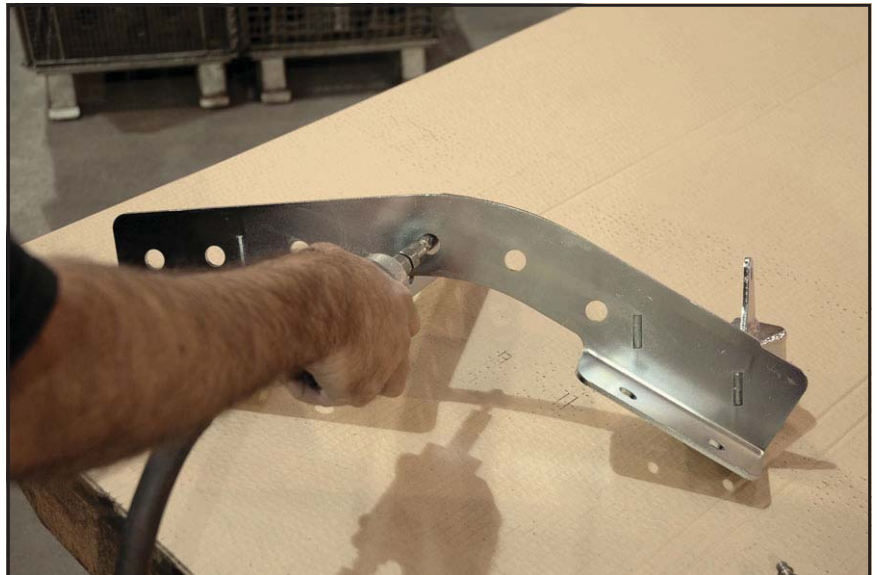

9. Loosely bolt the driver and passenger frame brackets to the upper crossmember using the 3/8" bolts, flat washers and locknuts provided. This completes the cradle assembly.



10. The floor-cut template will be used to mark the floor pan for the UCA mount to go through.

11. Place a straightedge along the bottom of the frame rail.

12. Place the template against the driver's side frame rail as shown. The bottom edge of the template must be 6-3/8" above the top edge of the straightedge.

When used on the **driver's side**, the word "TOP" will be visible.

When used on the **passenger's side**, the word "TOP" will be facing the body.

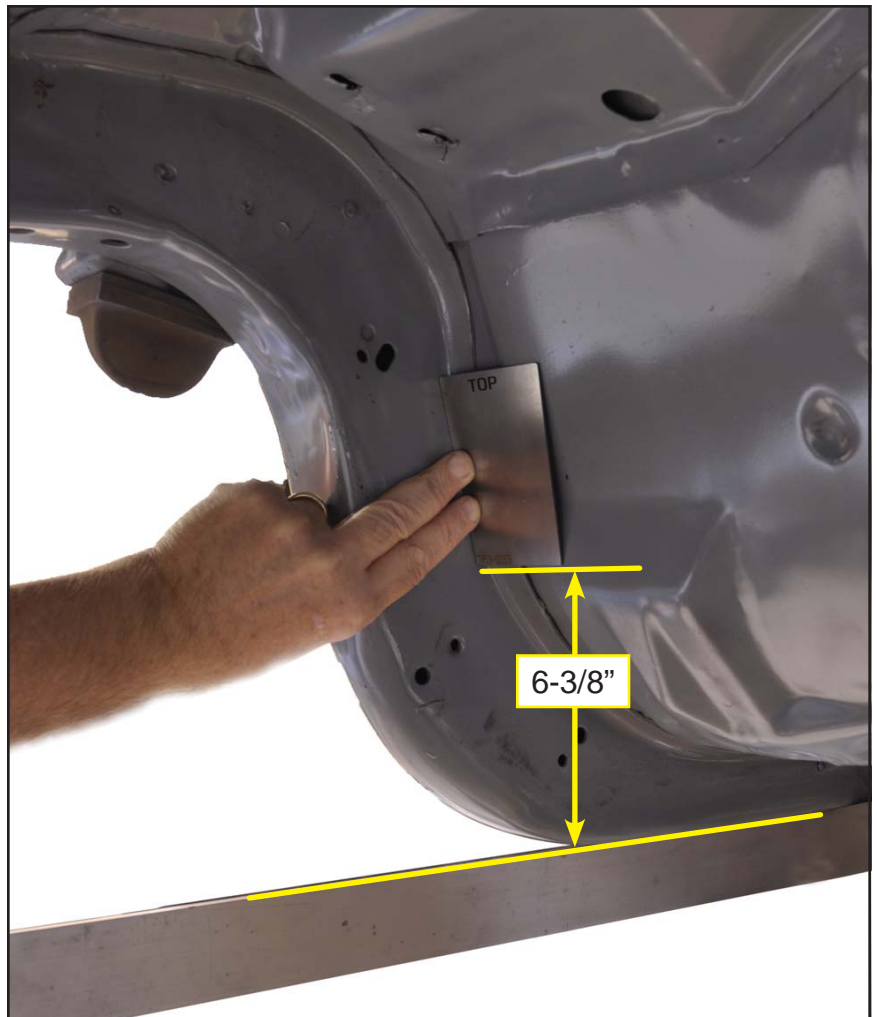

13. Once correctly positioned, mark a line around the template where the floor panel will be cut.

14. Cut the floor panel with a cutoff wheel along the marked line and the inside edge of the frame rail. The hole may need to be enlarged when fitting the UCA bracket assembly against the frame rail and through the floor panel. It is best to trim this carefully, so the hole is not too large for the mount.

15. The sheet metal surrounding the hole must be ground to bare metal on the inside and outside of the vehicle for welding.

Underside: 1/2" wide bare area
Inside: 1" wide bare area

16. Once the holes are cut in the floor pan. Position the cradle, pushing it against the frame rails until the frame brackets are completely seated.

17. Use C-clamps on the frame brackets to hold them firmly in place.

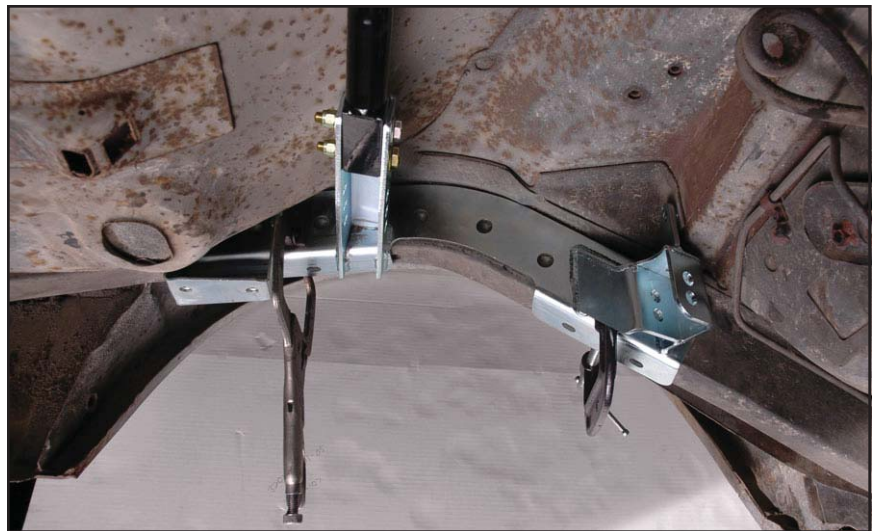
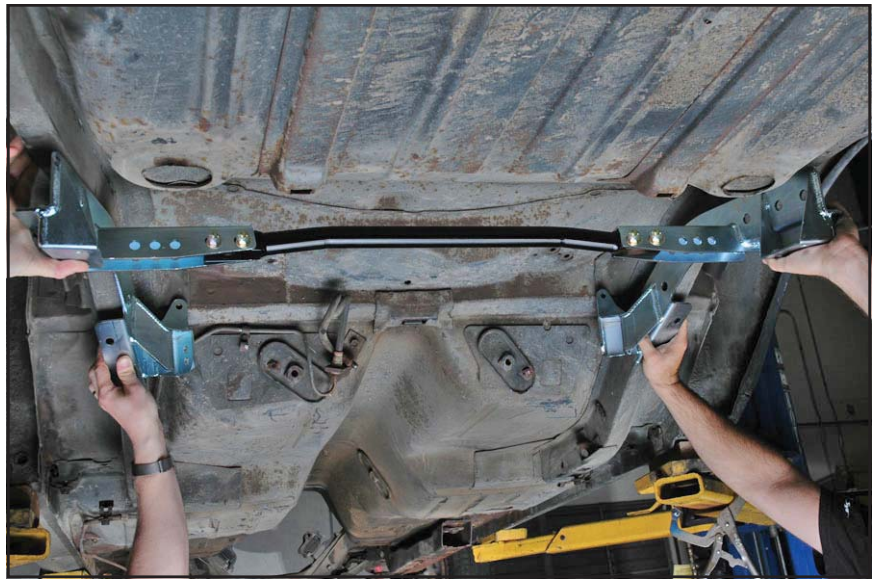

18. Ensure the cradle is positioned square to the chassis. On the driver side and passenger side, measure from the flat vertical section of undercarriage sheet metal to the lowest corner of the shock mount. Record this measurement. Measurements should be equal from one side of the vehicle to the other.



19. Verify the cradle frame brackets are clamped tightly against the inside and bottom surfaces of the frame rails.



20. Tighten the 3/8" upper crossmember mounting hardware to 35 lb-ft.



21. Clearly mark the weld-prep areas onto the undercarriage by scribing guidelines onto the surface of the frame rail. Scribe the overall outline of the bracket, the holes along the inside of the frame rail, and finally the eight oval holes along the bottom of the frame rail.

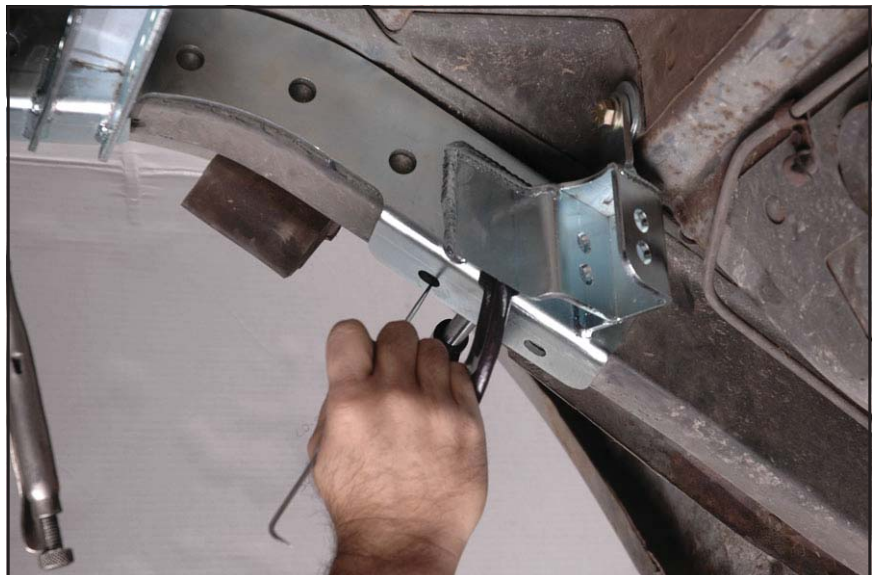

22. Use a 3/8"-diameter bit to drill a starting hole through the factory frame rail at each of the eight oval holes along the bottom of the frame rail ONLY. These holes will be opened up in a later step. The clamped cradle brackets will help to correctly guide the drill.



23. After all weld-prep areas are marked and starting holes drilled, remove the mounting hardware at the forward mounting tabs.

24. Unclamp the frame brackets but DO NOT loosen or remove the 3/8" upper-crossmember hardware at the frame brackets. Try not to bump the brackets from their correctly fit position. Lower the cradle assembly and set aside.

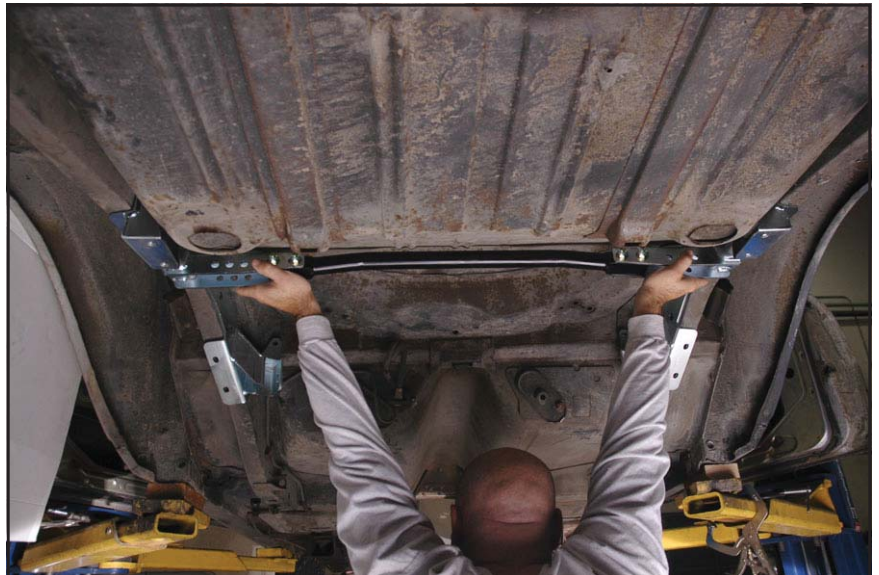

25. Use a die grinder, grinding-cone drill attachment, or file to enlarge the oval holes up to the scribe marks on the frame rails.

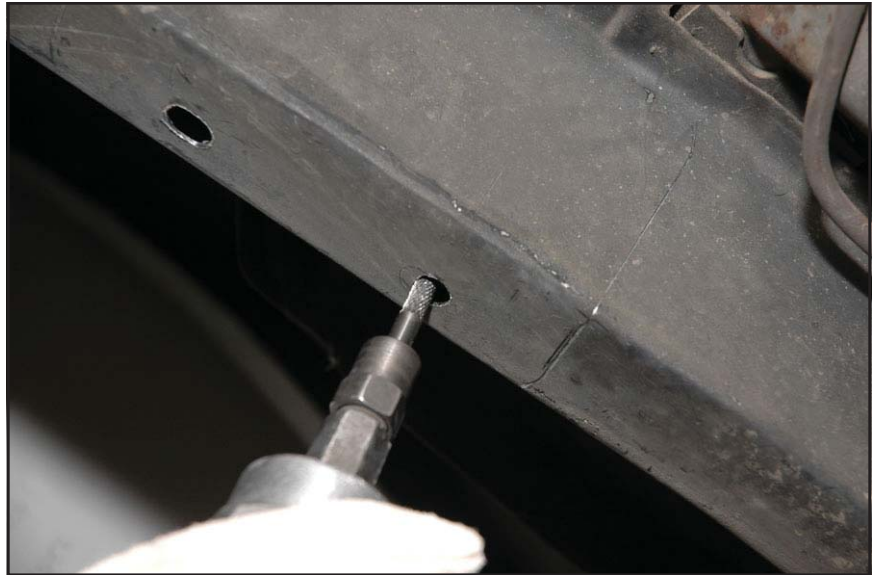

26. Use a scotch-brite disc pad or wire-brush drill attachment to expose bare metal along the weld areas marked on the frame rail earlier.



27. When all areas are sanded the frame should appear similar to the image to the right.



28. Install cradle into the car and align frame brackets with slotted holes in frame rail.

29. Clamp the cradle in place before installing the forward mount tab bolts.



30. Verify the shock bracket channel edge is the same distance from the flat vertical section of the undercarriage.



31. On one end of each square-corner u-bolt, install a 3/8" flat washer and locknut. DO NOT SKIP THIS STEP. It is possible to lose the u-bolt inside of the frame rail.



32. Slide the other end of the u-bolt into the hole in the frame brackets closest to the rear of the car, out through the second hole as shown, and secure with a flat washer and locknut.



33. Using the same procedure, install the u-bolt in the frame brackets closest to the front of car.



34. Once all the locknuts are in place, begin tightening each nut until it contacts the bracket. The u-bolt must “snugged-up” into a level, settled position before final tightening.



35. Torque each locknut to 35 lb-ft.



36. The installed cradle should appear exactly as the image to the lower right.



37. Tack weld each bracket to the frame rail, and then stitch weld along the longer seam lengths. The seams at the forward end of the brackets should be completely welded with the bead extending 1" past the corner. Place multiple tack welds around the holes on the inside of the frame rail to prevent from burning through the frame rail. Use the photo below as a guide.



38. Allow the welds to cool, then paint to protect the metal from rust. The zinc coating acts as an excellent base for paint.

39. At each forward UCA mount brackets, drill two 1/4" diameter hole through the triple-layer floor panel behind the rear seat, using the UCA forward mounts as a guide.

40. Secure the floor backing plate on the inside, behind the seat using the 1/4-28 x 7/8" hex bolts, flat washers and locknuts. The hardware holds the backing plate securely for welding.

41. Begin tack welding the backing plate to the floor and to the UCA bracket in the area closest to the 1/4" bolts. The backing plate will need to be hammered to follow the contour of the floor as it is tack welded in place.

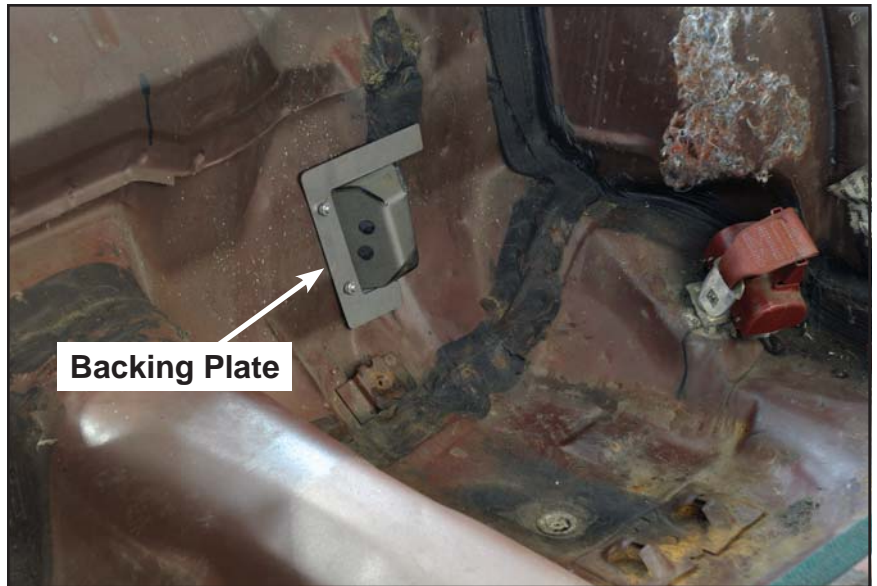
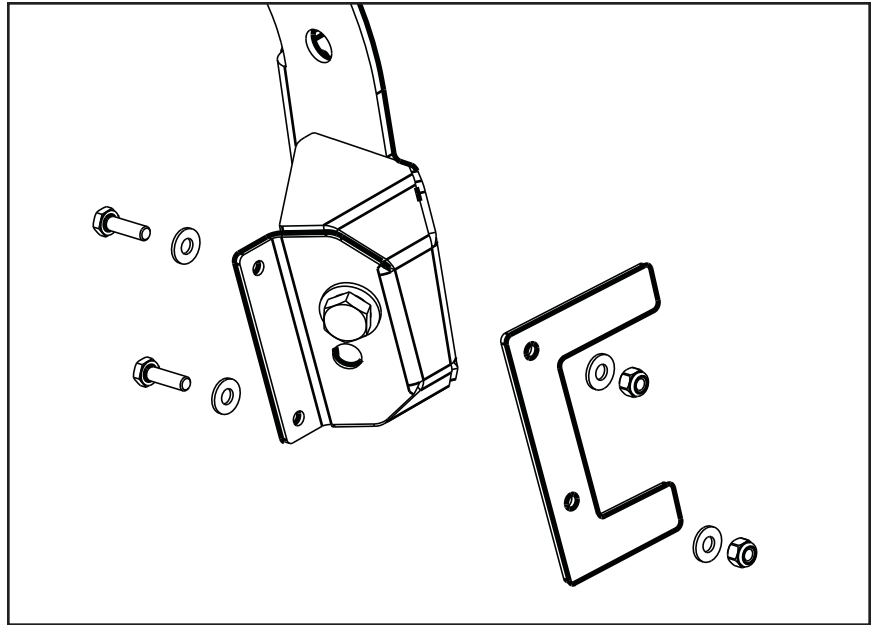

42. Once securely tack welded, weld completely along both interior seams.

43. From underneath the vehicle, weld completely around the bracket to floor seam.

44. After all welding has been completed, seam sealer should be applied around the UCA bracket and painted.

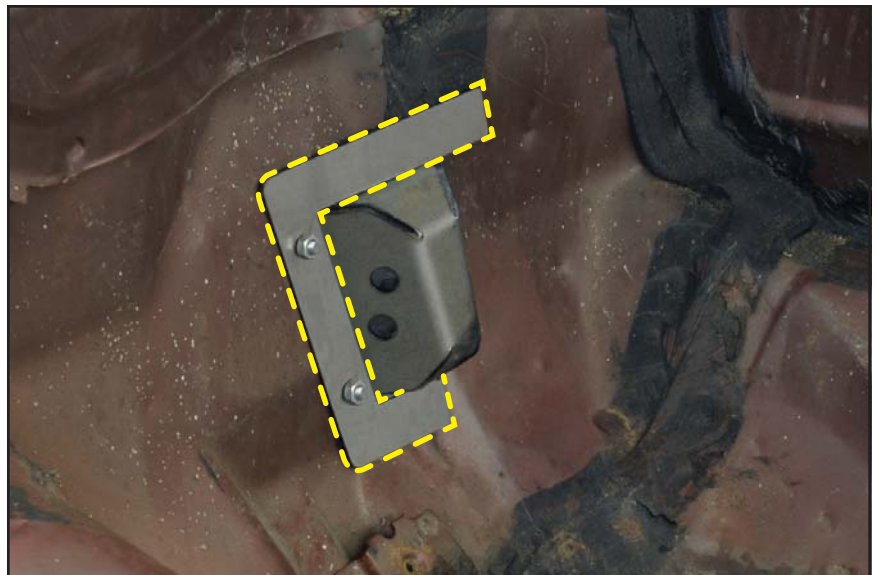

Installation Using Factory Rear-end Housing

45. All fluid must be drained and residue removed from housing to reduce risk of fire during welding.
46. A Chassisworks weld fixture must be used to accurately position and weld the upper brackets to axle tube. The 10-bolt fixture is shown bolted to the rear of the housing.

NOTE: Orientation of the housing fixture plate is inverted on '70-81 Camaros and Firebirds.

47. When leaving the rearend cover on the housings use the provided spacers. Also make sure the bracket bosses are at the forward holes. If welding with the cover removed the spacers are NOT used and the bracket bosses are mounted in the rear holes. Only tack weld the brackets at this time.

48. Use a 1/2" diameter drill bit to enlarge the holes in the factory spring plates for the u-bolts.

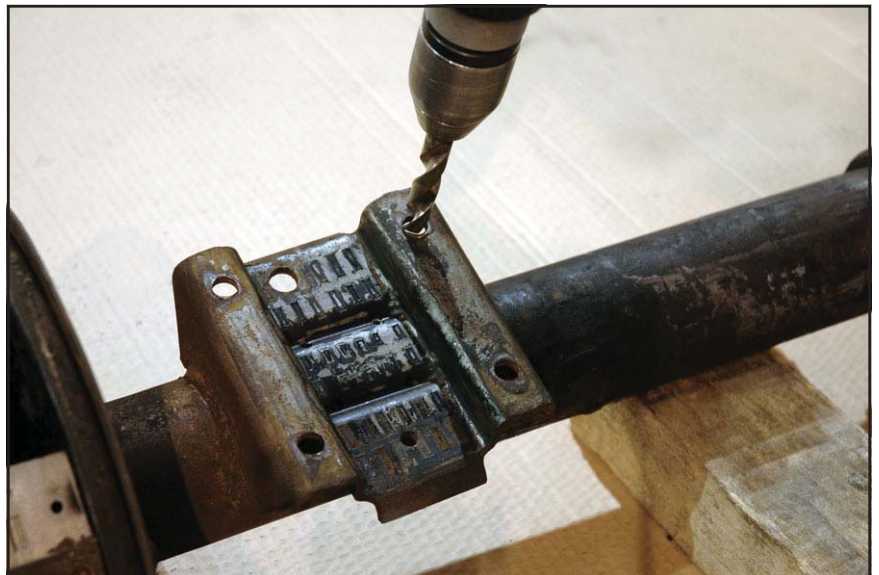
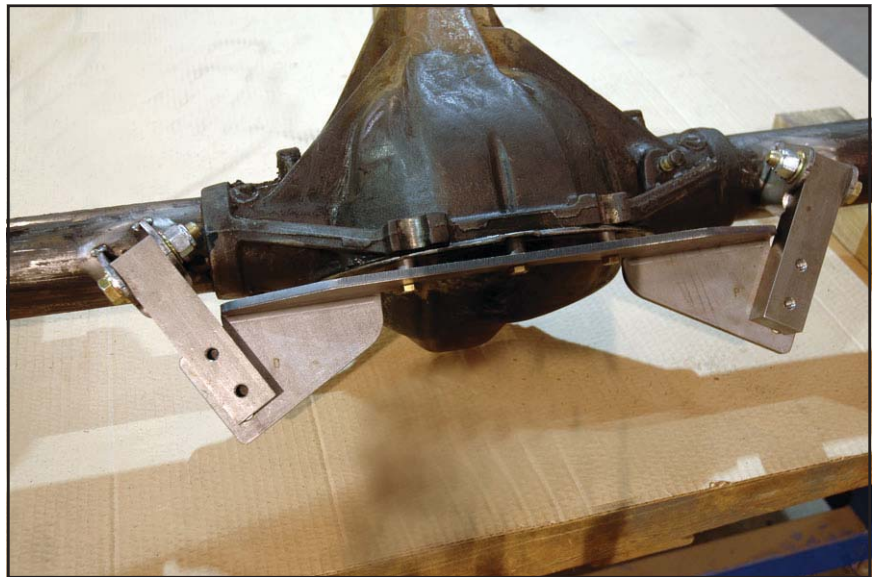
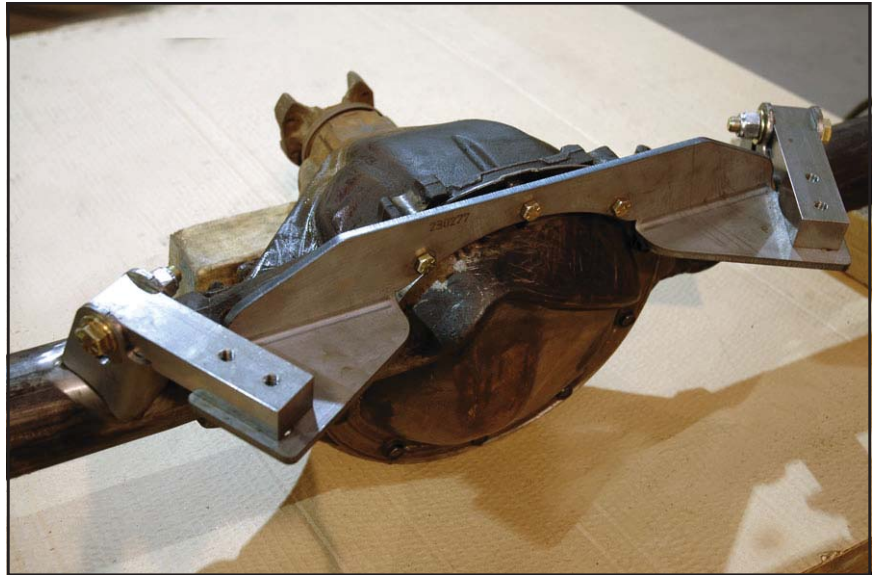

49. Position lower axle brackets onto rearend-housing spring plates. Place the 1/2" U-bolts over the axle tube and through the holes in the axle bracket. Secure with flat washers and locknuts. Tighten evenly to 60 lb-ft.

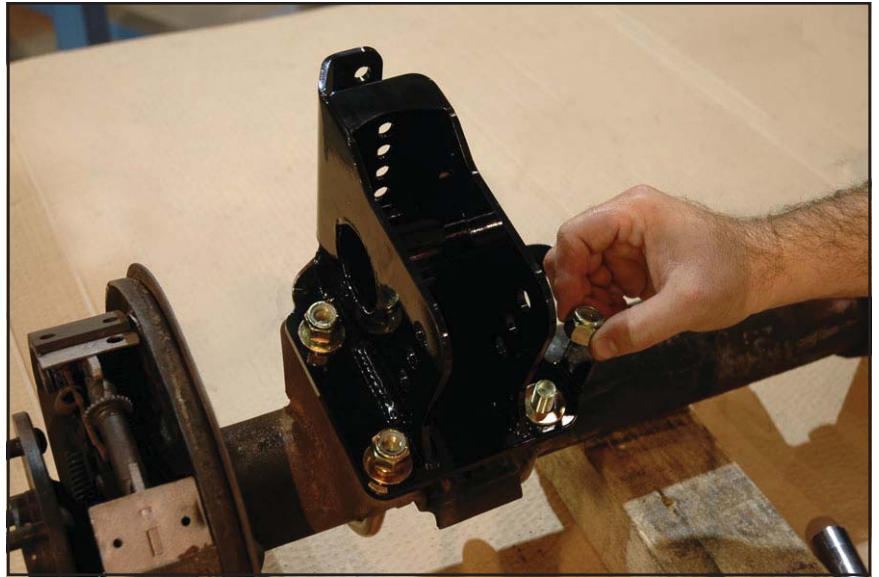

50. Adjust the lower link bars to 24" center to center of the mounting holes, if applicable.

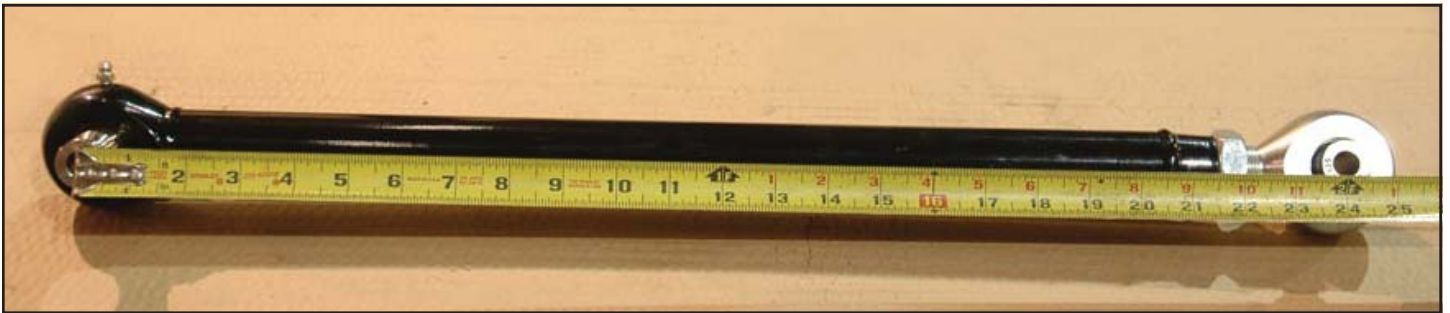

51. Install the lower suspension links at the factory front leaf spring mount using 1/2" diameter bolts, flat washers, and locknuts. Grease zerk fittings must point downward. The bolts must be installed from the direction shown in the photo to allow clearance for the locking nut once on the vehicle. Torque to 65 lb-ft.

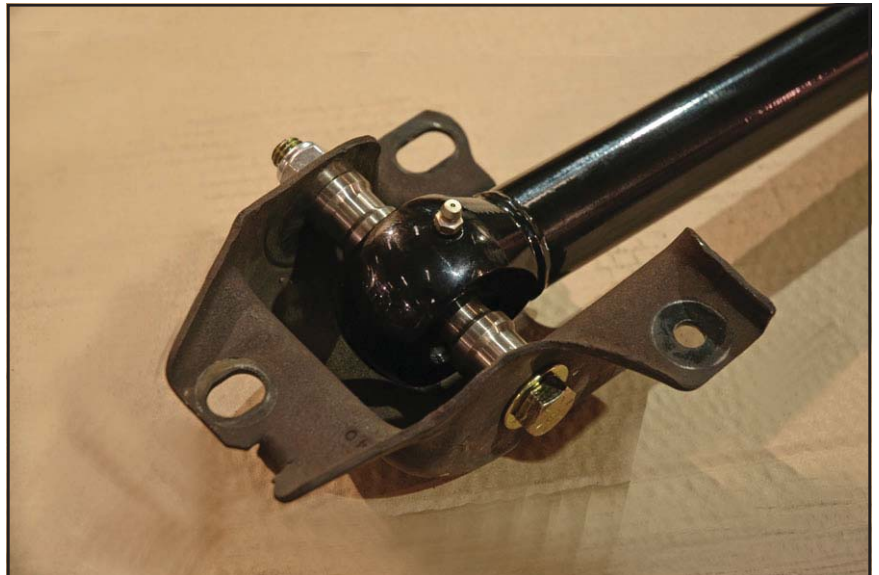

52. Use the factory bolts to install the front spring hanger into the frame.



53. Position the rearend housing under the car on jack stands. Attach the lower suspension links to the axle brackets with 1/2" bolts, flat washers, and locknuts. Use the second hole from the bottom on the axle brackets for initial installation. Torque to 65 lb-ft.

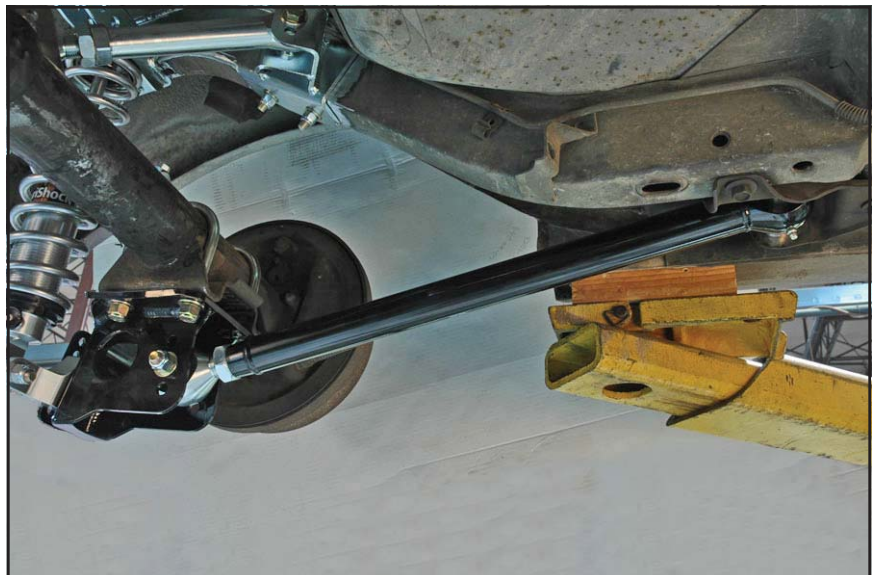

54. Adjust upper suspension links to 9-1/2" center to center of the mounting holes.

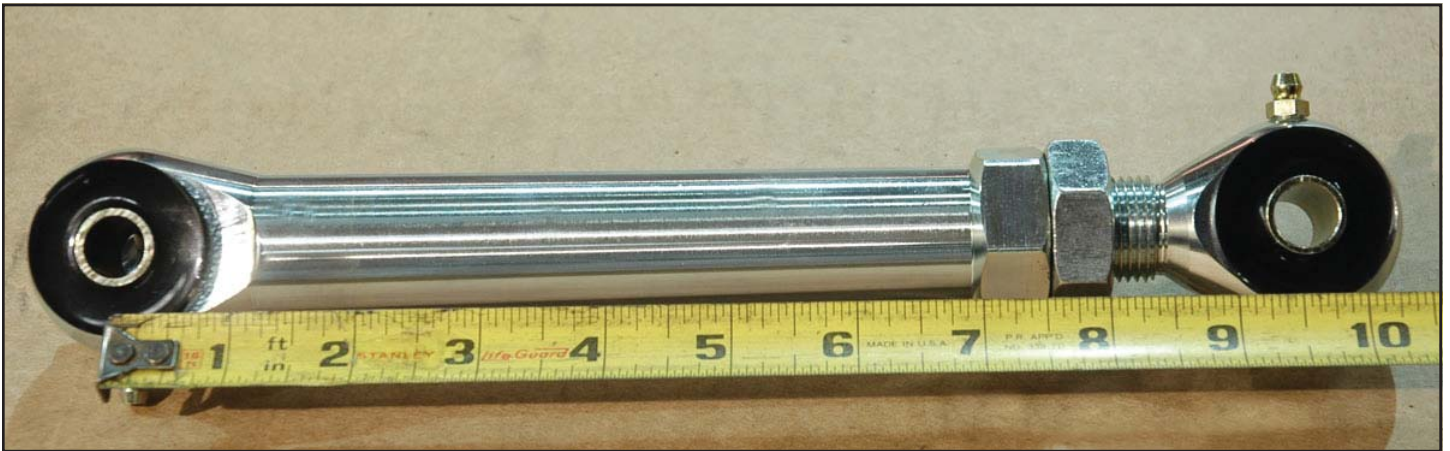

55. Attach the non-adjustable end of upper links to the upper holes of the cradle with 1/2" bolts, flat washers and locknuts. Grease zerk must point down.



56. Bolt opposite end of each upper link to the lower hole at the axle bracket. Grease zerk must point up.



57. Install the billet lower-shock mounts at the lower axle bracket using 3/8" hardware. Leave one blank hole below the mount for initial setup.

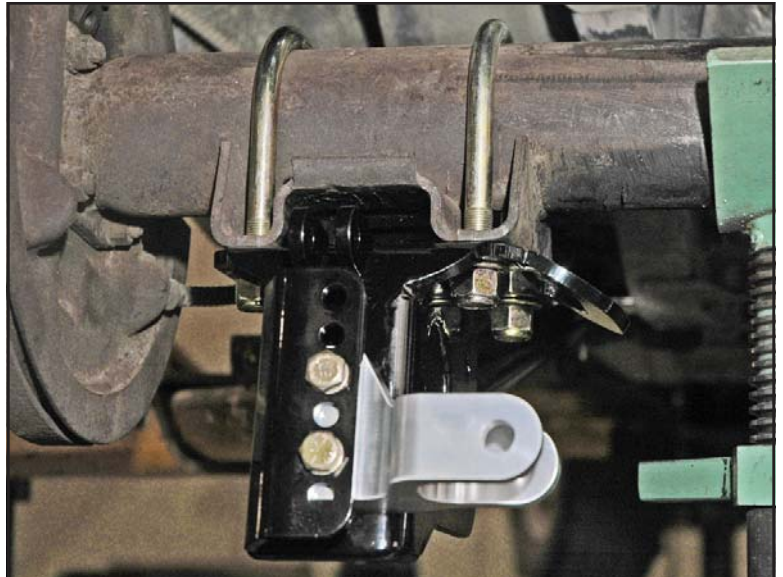

58. Raise rearend housing so that the distance from the billet-shock-mount hole to the center upper-shock-mount hole measures 13-1/2". This is the baseline ride-height position.



59. The upper suspension links can now be used to center the rearend in relation to the chassis, and then to adjust pinion angle. Link ends will need to be unbolted from axle brackets to adjust length. One full turn IN on one link and OUT on the other link will move the rearend housing approximately 3/16" toward the shortened side. Measuring from a point on the frame to the end of the axle on each side is the best way to center the housing in the car.



60. To adjust pinion angle turn both upper adjusters equal amounts IN or OUT.

61. Note: Carefully read the Pinion Angle section at the end of this installation guide before determining the correct pinion angle.



62. Install coil-over shocks with 1/2" bolts, flat washers and locknuts. Do not install springs at this time. The top shock eye should be mounted in the center hole. Adjustments can be made later to soften ride quality by moving to the inner hole, or stiffen ride quality by moving to the outer hole.
63. Note: Spherical-bearing shocks must use spacer set VAS 508-100. Place one or two washers against each side of the bearing for correct fit. The mounting clevis is purposely oversized to also allow use of urethane-bushing shocks.
64. Adjust both shocks to their softest setting, then temporarily install into cradle using 1/2 x 2-3/4" bolts with locknuts.
65. Nuts can be threaded on by hand so that bolts do not slip out during next step. Shocks will be used to limit travel during next step.



66. Using a jack, cycle the rear suspension through its full range of vertical travel and body roll in both directions to check for binding and potential clearance issues at all suspension joints and along the lengths of any moving parts including the rearend housing.





67. Once clearance has been verified, remove the housing and final weld the upper link brackets to the housing.
68. If possible, the exhaust system should be installed at this time while the rearend can be easily manipulated to check for proper clearance.
69. Coil springs can be installed onto shocks, then shocks reinstalled onto cradle. Torque hardware to 50 lb-ft.
70. Note: When moving lower shock mounts or suspension link mounting locations the suspension must be checked for binding and adequate clearance throughout its full range of vertical travel and body roll.

71. Refer to coil-over shock and VariSpring installation guides for specific instructions regarding adjusting spring preload and valve adjustment.
72. Carefully read the spring section on page 31.
73. Refer to anti-roll-bar installation guide for specific instructions.
74. Reassemble the rear-end components and the installation is complete.



Mounting Options and Final Adjustments

Lower Suspension Link

Mounting Position: The lower link has three (factory housing) or four (FAB9™ housing) mounting positions at the axle bracket. Ideally, to minimize suspension steering effects (roll steer), the link should be set as close to horizontal as possible with the suspension at ride height. Lowering the rear position from horizontal will also increase available traction, but also increases roll oversteer.

Length (pivot-ball link only): Correct adjusted length is 24.00", measured at the center of the bolt holes. Due to chassis variances it may be necessary to adjust the lower suspension link lengths to position the rear end housing square to the chassis.

Upper Suspension Link

Mounting Position: The upper link has two mounting positions at the cradle bracket and axle bracket. The starting installation position provides the largest anti-squat percentage and provides more immediate traction to the rear tires (less chassis movement). Lowering the front position and/or raising the rear position provides less anti-squat and a more gradual transfer of weight to the rear tires (more chassis movement).

Length: Correct adjusted length is 9.50", measured at the center of the bolt holes. Due to chassis variances it may be necessary to center the housing in relation to the chassis by adjusting the upper suspension link lengths.

Shock Absorber

Lower Mounting Position: The lower shock mount can be moved to one of four positions to alter ride height in 5/8" increments.

Upper Mounting Position: The upper shock mount can be moved to one of three positions along the upper crossmember. Ride height is altered in 1/4" increments at each position with approximately a 5% change in shock/spring stiffness and ride quality.

Outermost hole = highest/stiffest; Innermost hole = lowest/softest.

Spring Preload:

Refer to VariShock coil-over installation guide (899-031-200 or 899-031-220) for detailed information regarding spring preload and correct balance of travel at ride height.

Under no circumstance should the lower spring seat be used to adjust the shock length at ride-height to less than 13" or more than 14". Damage to the shock absorbers will occur, and you will be charged to repair them.

Maintenance

Suspension Link Lubrication

Each suspension pivot assembly can be lubricated using a standard grease gun. Pivot-ball links without a grease zerk fitting can be lubricated by removing the locking set screw and temporarily installing a zerk fitting.

Pivot-Ball Preload

The retaining ring can be tightened to remove any free-play that develops in the pivot-ball mechanism. Remove the locking set screw and turn the retaining ring clockwise, using a common spanner wrench, to the next set screw position.

Pinion Angle

Our recommended pinion angle of one to two degrees down, as compared to the engine crankshaft angle, serves as a starting point for your particular application. Installed components, available traction, and specific application will have some affect on the correct settings for your vehicle.

Pinion angle is to be set at ride height by equally adjusting the upper control arm lengths. Upper arm must be unbolted from the axle tabs and jam nut loosened for adjustment. Be sure to tighten the jam nuts and mounting hardware to the torque value specified in this installation guide.

Understanding Pinion Angle

The pinion angle is a very misunderstood measurement. The pinion angle is simply the difference in degrees of the engine crankshaft or drivetrain angle and the third member. The pinion angle is not a tuning aid. It is something that has to be set, but you do not adjust it for bite.

Measuring the Drivetrain Angle

This can be taken from the vertical surface of the transmission tailshaft, the oil pan rail, or the front face of the harmonic balancer. Most production vehicle drivetrain angles will run slightly downhill towards the rear bumper. A typical measurement may be 2 degrees.

Adjusting the Third Member Angle

The third member should be adjusted so that at ride height there is one to two degrees difference in the measured drivetrain angle and the third member angle. The pinion must point down 1 or 2 degrees from the engine or drivetrain angle. As an example, the two degrees downhill drivetrain angle previously established would require the third member to be set at zero degrees or parallel to the ground for a difference of two degrees. Lengthening the upper control arms to tilt the pinion upward to a measurement of one degree would give a difference of one degree when compared to the drivetrain angle.

Greater traction from wider or softer tire compounds combined with higher horsepower levels will require a greater pinion angle than low traction, low horsepower applications. The object is to get the two angles to be equal during acceleration. A poly-bushing link is more compliant and will flex more than the pivot-ball link, so poly links may require more initial pinion angle.

Fastener Torque Specifications

Fastener Description	Location	Torque Value
5/16-24 x 1" Hex Head Cap Screw	Cradle to factory pinion bump stop mount	19 lb-ft
1/2-20 x 2-1/4 Hex Head Cap Screw, Grade 8	Shock mounts at cradle and lower shock mounts	50 lb-ft
7/16" U-bolts	Axle mount at leaf spring pad	50 lb-ft
5/8-18 x 2-3/4" Hex Head Cap Screw, Grade 8	Upper arm at cradle and welded axle tube mounts Lower arm at axle mount	75 lb-ft
5/8-18 x 1-1/2" Socket Head (Allen) Cap Screw	Lower shock mount to axle mount	75 lb-ft

Spring Rate Selection

Spring rate affects ride quality, ride height, roll rate, and performance handling characteristics. Differences in vehicles such as aluminum engine components, vehicle weight distribution, fiberglass body parts, chassis stiffening as well as wheel-size and offset and the specific performance application, should be taken into consideration. Additional tuning springs are available at a discount when purchased with a system. A good spring-rate baseline for Mustangs with rear g-Bar or g-Link, and with a small-block engine seeing regular street use would be 175-200 lbs/in., depending upon desired ride quality. A good baseline is for every 100-lb. change in rear vehicle weight, the spring rate needs to change by 25 lb/in.

Rear Weight (lbs)	Part Number	Rate (lbs)	Travel (in)
925-1000	VAS 21-12110	110	7.91
1000-1100	VAS 21-12130	130	8.43
1100-1225	VAS 21-12150	150	7.61
1225-1350	VAS 21-12175	175	7.60
1350-1575	VAS 21-12200	200	7.45
1575-1825	VAS 21-12250	250	7.00
1825-2075	VAS 21-12300	300	7.07
2075-2350	VAS 21-12350	350	7.00

If you have to add more than 1" of spring preload to achieve the shock's minimum ride-height length (13" eye to eye), a stiffer spring is needed.

Shock Angle

The upper shock eye can be mounted in one of three positions to alter the effectiveness of the spring and shock against suspension movement. This adjustment can be used to soften or stiffen ride quality in roughly 5% increments. The center mount is the initial mounting position. Moving to the inner hole softens the suspension. Moving to the outer hole stiffens the suspension.

If the shock angle is changed you must verify that the shock is still within the allowable ride height range of 13 to 14 inches, eye to eye.

Mount Position Effect on Ride

Inner	Center	Outer
-5%	Base	+5%



WARRANTY NOTICE:

There are NO WARRANTIES, either expressed or implied. Neither the seller nor manufacturer will be liable for any loss, damage or injury, direct or indirect, arising from the use or inability to determine the appropriate use of any products. Before any attempt at installation, all drawings and/or instruction sheets should be completely reviewed to determine the suitability of the product for its intended use. In this connection, the user assumes all responsibility and risk. We reserve the right to change specification without notice. Further, Chris Alston's Chassisworks, Inc., makes **NO GUARANTEE** in reference to any specific class legality of any component. **ALL PRODUCTS ARE INTENDED FOR RACING AND OFF-ROAD USE AND MAY NOT BE LEGALLY USED ON THE HIGHWAY.** The products offered for sale are true race-car components and, in all cases, require some fabrication skill. **NO PRODUCT OR SERVICE IS DESIGNED OR INTENDED TO PREVENT INJURY OR DEATH.**

Chris Alston's Chassisworks
8661 Younger Creek Drive
Sacramento, CA 95828
Phone: 916-388-0288
Technical Support: tech@cachassisworks.com

